

FCA3000 and FCA3100 Series Timer/Counter/Analyzers
MCA3000 Series Microwave Counter/Analyzers
User Manual



077-0493-00

Tektronix

**FCA3000 and FCA3100 Series Timer/Counter/Analyzers
MCA3000 Series Microwave Counter/Analyzers
User Manual**

Revision A

www.tektronix.com

077-0493-00

Tektronix

Copyright © Tektronix. All rights reserved. Licensed software products are owned by Tektronix or its subsidiaries or suppliers, and are protected by national copyright laws and international treaty provisions.

Tektronix products are covered by U.S. and foreign patents, issued and pending. Information in this publication supersedes that in all previously published material. Specifications and price change privileges reserved.

TEKTRONIX and TEK are registered trademarks of Tektronix, Inc.

TimeView is a trademark of Pendulum AB.

Contacting Tektronix

Tektronix, Inc.
14150 SW Karl Braun Drive
P.O. Box 500
Beaverton, OR 97077
USA

For product information, sales, service, and technical support:

- In North America, call 1-800-833-9200.
- Worldwide, visit www.tektronix.com to find contacts in your area.

Warranty

Tektronix warrants that this product will be free from defects in materials and workmanship for a period of three (3) years from the date of shipment. If any such product proves defective during this warranty period, Tektronix, at its option, either will repair the defective product without charge for parts and labor, or will provide a replacement in exchange for the defective product. Parts, modules and replacement products used by Tektronix for warranty work may be new or reconditioned to like new performance. All replaced parts, modules and products become the property of Tektronix.

In order to obtain service under this warranty, Customer must notify Tektronix of the defect before the expiration of the warranty period and make suitable arrangements for the performance of service. Customer shall be responsible for packaging and shipping the defective product to the service center designated by Tektronix, with shipping charges prepaid. Tektronix shall pay for the return of the product to Customer if the shipment is to a location within the country in which the Tektronix service center is located. Customer shall be responsible for paying all shipping charges, duties, taxes, and any other charges for products returned to any other locations.

This warranty shall not apply to any defect, failure or damage caused by improper use or improper or inadequate maintenance and care. Tektronix shall not be obligated to furnish service under this warranty a) to repair damage resulting from attempts by personnel other than Tektronix representatives to install, repair or service the product; b) to repair damage resulting from improper use or connection to incompatible equipment; c) to repair any damage or malfunction caused by the use of non-Tektronix supplies; or d) to service a product that has been modified or integrated with other products when the effect of such modification or integration increases the time or difficulty of servicing the product.

THIS WARRANTY IS GIVEN BY TEKTRONIX WITH RESPECT TO THE PRODUCT IN LIEU OF ANY OTHER WARRANTIES, EXPRESS OR IMPLIED. TEKTRONIX AND ITS VENDORS DISCLAIM ANY IMPLIED WARRANTIES OF MERCHANTABILITY OR FITNESS FOR A PARTICULAR PURPOSE. TEKTRONIX' RESPONSIBILITY TO REPAIR OR REPLACE DEFECTIVE PRODUCTS IS THE SOLE AND EXCLUSIVE REMEDY PROVIDED TO THE CUSTOMER FOR BREACH OF THIS WARRANTY. TEKTRONIX AND ITS VENDORS WILL NOT BE LIABLE FOR ANY INDIRECT, SPECIAL, INCIDENTAL, OR CONSEQUENTIAL DAMAGES IRRESPECTIVE OF WHETHER TEKTRONIX OR THE VENDOR HAS ADVANCE NOTICE OF THE POSSIBILITY OF SUCH DAMAGES.

[W4 – 15AUG04]

Table of Contents

General Safety Summary	iii
Preface	v
About This Manual	v
Features	v
Powerful and Versatile Functions	vi
No Mistakes	vi
Design Innovations	vii
Remote Control	vii
Unpacking	1
Standard Accessories	1
Identification	1
Installation	1
Getting Acquainted with Your Instrument	3
Front Panel	3
Input Connectors	4
Rear Panel	5
Main Screen	6
Controls	10
Entering Numeric Values	14
Menus	14
Input Signal Conditioning	21
Input Controls	21
How to Reduce or Ignore Noise and Interference	26
Frequency Measurements	31
Theory of Measurement	31
Input A, B	36
Input C	38
Ratio A/B, B/A, C/A, C/B	38
Burst A, B, C	38
Frequency Modulated Signals	41
AM Signals	44
Period	46
Frequency	47
Time Measurements	48
Introduction	48
Time Interval	49
Rise/Fall Time A/B	49
Time Interval Error (TIE) (FCA3100 Series Only)	50
Pulse Width A/B	51

Duty Factor A/B	51
Time Measurement Errors	52
Phase Measurements	54
Resolution	55
Possible Errors	55
Totalize (FCA3100 Series Only)	59
Voltage Measurements	63
V_{MAX} , V_{MIN} , and V_{PP}	63
V_{RMS}	63
Math and Statistical Measurements	65
Averaging	65
Mathematics	65
Statistics	66
Limit Testing	71
Arming	73
Guidelines	73
Start and Stop Arming	74
Arming Input Signals	75
Arming and Setup Time	76
Arming Examples	77
Arming and Profiling	82
Appendix A: Default Instrument Settings	85
Appendix B: Controlling Measurement Timing	87
The Measurement Process	87
Index	

General Safety Summary

Review the following safety precautions to avoid injury and prevent damage to this product or any products connected to it.

To avoid potential hazards, use this product only as specified.

Only qualified personnel should perform service procedures.

While using this product, you may need to access other parts of a larger system. Read the safety sections of the other component manuals for warnings and cautions related to operating the system.

To Avoid Fire or Personal Injury

Use proper power cord. Use only the power cord specified for this product and certified for the country of use.

Connect and disconnect properly. Do not connect or disconnect probes or test leads while they are connected to a voltage source.

Ground the product. This product is grounded through the grounding conductor of the power cord. To avoid electric shock, the grounding conductor must be connected to earth ground. Before making connections to the input or output terminals of the product, ensure that the product is properly grounded.

Observe all terminal ratings. To avoid fire or shock hazard, observe all ratings and markings on the product. Consult the product manual for further ratings information before making connections to the product.

The inputs are not rated for connection to mains or Category II, III, or IV circuits.

Do not apply a potential to any terminal, including the common terminal, that exceeds the maximum rating of that terminal.

Power disconnect. The power cord disconnects the product from the power source. Do not block the power cord; it must remain accessible to the user at all times.

Do not operate without covers. Do not operate this product with covers or panels removed.

Do not operate with suspected failures. If you suspect that there is damage to this product, have it inspected by qualified service personnel.

Avoid exposed circuitry. Do not touch exposed connections and components when power is present.

Do not operate in wet/damp conditions.

Do not operate in an explosive atmosphere.

Keep product surfaces clean and dry.

Provide proper ventilation. Refer to the manual's installation instructions for details on installing the product so it has proper ventilation.

Terms in This Manual These terms may appear in this manual:



WARNING. *Warning statements identify conditions or practices that could result in injury or loss of life.*



CAUTION. *Caution statements identify conditions or practices that could result in damage to this product or other property.*

Symbols and Terms on the Product

These terms may appear on the product:

- DANGER indicates an injury hazard immediately accessible as you read the marking.
- WARNING indicates an injury hazard not immediately accessible as you read the marking.
- CAUTION indicates a hazard to property including the product.

The following symbol(s) may appear on the product:



Preface

About This Manual

This manual contains operation information for the FCA3000 and FCA3100 Series Timer/Counter/Analyzer and the MCA3000 Series Microwave Counter/Analyzer.

To simplify the references, features that are common to all instruments are not marked with instrument names. Features that are specific to a particular instrument or instrument series are clearly marked.

Instrument references:

- **FCA3X00** means any FCA3000 Series or FCA3100 Series instrument
- **FCA3000** means any FCA3000 Series instrument (FCA3000, FCA3003, FCA3020)
- **FCA3100** means any FCA3100 Series instrument (FCA3100, FCA3103, FCA3120)
- **MCA3000** means any MCA3000 Series instrument (MCA3027 or MCA3040)

Features

- Wide measurement frequency range to 40 GHz
- Fastest microwave counter on the market (25 ms acquisition time)
- Industry's only frequency counter with a graphical display
- High resolution down to 50 ps single shot (time), or 12 digits/s (frequency)
- Simultaneous display of signal frequency and voltage parameters
- Trigger sensitivity of 15 mV_{rms} from DC to 200 MHz
- Voltage resolution to 1 mV
- Fast USB/GPIB bus transfer speeds, up to 15 k measurements per second (block mode)
- Zero-dead time frequency/period measurements
- Best Oven-controlled Crystal Oscillator (OCXO) time base options (1.5E-8/year)
- MCA3000 Series offers microwave CW frequency measurements and very short burst measurements down to 40 ns
- Programmable Pulse output from 0.5 Hz to 50 MHz (FCA3100 Series)
- 10 MHz reference output oscillator

- Measurement Statistics, Histogram, and Trend Plot modes
- Front or rear input connection options
- *MCA3000 Series*: An optional built-in Li-Ion battery supply provides instant high-precision measurements in the field and true UPS operation

Powerful and Versatile Functions

A unique performance feature in your new instrument is the comprehensive arming possibilities, which allow you to characterize virtually any type of complex signal concerning frequency and time.

For instance, you can insert a delay between the external arming condition and the actual arming of the instrument. Read more about Arming in Chapter 5, *Measurement Control*.

In addition to the traditional measurement functions of a timer/instrument, these instruments have a multitude of other functions such as phase, duty factor, rise/fall time, and peak voltage. The instrument can perform all measurement functions on both Input A and Input B. Most measurement functions can be armed, either using one of the main inputs or using a separate arming channel (E).

By using the built-in mathematics and statistics functions, the instrument can process the measurement results in the instrument, without the need for an external controller or software. Math functions include inversion, scaling, and offset. Statistics functions include Max, Min and Mean, Standard deviation, and Allan deviation, on sample sizes up to 2×10^9 .

No Mistakes

You will soon find that your instrument is more or less self-explanatory with an intuitive user interface. A menu tree with few levels makes the timer/instrument easy to operate. The large backlit graphic LCD is the center of information and can show you several signal parameters at the same time as well as setting status and operator messages.

Statistics based on measurement samples can easily be presented as histograms or trend plots in addition to standard numerical measurement results like max, min, mean, and standard deviation.

The AUTO function triggers automatically on any input waveform. A bus-learn mode simplifies GPIB programming. With bus-learn mode, manual instrument settings can be transferred to the controller for later reprogramming. There is no need to learn code and syntax for each individual instrument setting if you are an occasional bus user.

Design Innovations

State of the Art Technology Gives Durable Use

These counters are designed for quality and durability. The design is highly integrated. The digital counting circuitry consists of just one custom-developed FPGA and a 32-bit microcontroller. The high integration and low component count reduces power consumption and results in an MTBF of 30,000 hours. Modern surface-mount technology ensures high production quality. A rugged mechanical construction, including a metal cabinet that withstands mechanical shocks and protects against EMI, is also a valuable feature.

High Resolution

The use of *reciprocal interpolating counting* in this instrument results in excellent relative resolution of 12 digits/s for all frequencies.

The measurement is synchronized with the input cycles instead of the time base. Simultaneously with the normal “digital” counting, the instrument takes analog measurements of the time between the start/stop trigger events and the next following clock pulse. This is done in four identical circuits by charging an integrating capacitor with a constant current, starting at the trigger event. Charging is stopped at the leading edge of the first following clock pulse. The stored charge in the integrating capacitor represents the time difference between the start trigger event and the leading edge of the first following clock pulse. A similar charge integration is made for the stop trigger event.

When the “digital” part of the measurement is ready, the stored charges in the capacitors are measured by Analog/Digital Converters.

The instrument calculates the result after completing all measurements, that is, the digital time measurement and the analog interpolation measurements. The result is that the basic digital resolution of ± 1 clock pulse (10 ns) is reduced to 100 ps for the FCA3000 Series and 50 ps for the FCA3100 Series.

Since the measurement is synchronized with the input signal, the resolution for frequency measurements is very high and independent of frequency. The counters have 14 display digits so that the display itself does not restrict the resolution.

Remote Control

This instrument is programmable using two interfaces, GPIB and USB.

The GPIB interface offers full general functionality and compliance with the latest standards in use, the IEEE 488.2 1987 for HW and the SCPI 1999 for SW. There is also a second GPIB mode that emulates the Agilent 53131/132 command set for easy exchange of instruments in operational ATE systems.

The USB interface is mainly intended for use with the optional TimeView™ analysis software. The communication protocol is a proprietary version of SCPI.

Fast GPIB Bus

These counters are not only extremely powerful and versatile instruments, they also feature fast bus communications. The bus transfer rate is up to 2000 triggered measurements/s. Array measurements to the internal memory can reach 250 k measurements/s.

This very high measurement rate makes new measurements possible. For example, you can perform *jitter analysis* on several tens of thousands of pulse width measurements and capture them in a second.

An extensive Programmer Manual describes the available SCPI-based programming commands.

The instrument is easy to use in GPIB environments. A built-in *bus-learn* mode enables you to make all instrument settings manually and transfer them to the controller. The response can later be used to reprogram the instrument to the same settings. This eliminates the need for the occasional user to learn all individual programming codes.

Complete (manually set) instrument settings can also be stored in 20 internal memory locations and can easily be recalled. Ten of the internal memory locations can be user protected.

Unpacking

Check that the shipment is complete and that no damage has occurred during transportation. If the contents are incomplete or damaged, file a claim with the carrier immediately. Also notify your local Tektronix representative in case repair or replacement is required.

Standard Accessories

The shipment should contain the following:

- FCA3000, FCA3100, or MCA3000 Series instrument
- Printed Quick Start User Manual
- Certificate of Calibration
- Options you ordered should be installed (See page 1, *Identification*.)
- *FCA3000, FCA3100, and MCA3000 Series Timer/Counter/Analyzers Documentation and Connectivity Software CD*
- National Instruments SignalExpress™ Limited software CD
- Line cord

Identification

The identification label on the rear panel shows instrument model, serial number, and configuration information. (See page 5, *Rear Panel*.) You can also push **User Opt > About** to display instrument information.

Installation

Supply Voltage

You can connect the instrument to an AC supply with a voltage rating of 90-265 V_{rms}, 45-440 Hz. The instrument automatically adjusts itself to the input line voltage.

There is no user-serviceable fuse for the FCA3X00 or MCA3000 Series instruments.



CAUTION. *If this fuse is blown, it is likely that the power supply is badly damaged. Do **not** replace the fuse. Send the instrument to a Tektronix Service Center. Removing the cover for repair, maintenance and adjustment must be done only by qualified and trained personnel, who are fully aware of the hazards involved.*

The warranty commitments are rendered void if unauthorized access to the interior of the instrument has taken place during the given warranty period.

Optional Battery Supply (MCA3000 Series Only)

Option BT lets you run the instrument from an optional Lithium-Ion battery. You must charge the battery before use or storage. The instrument charges the battery automatically when connected to line power or an external DC source, whether the instrument is in standby or turned on. See the specifications for charging time in different modes of operation.

Grounding

Grounding faults in the line voltage supply will make any instrument connected to it dangerous. Before connecting any unit to the power line, you must make sure that the protective ground functions correctly. Only then can a unit be connected to the power line and only by using a three-wire line cord. No other method of grounding is permitted. Extension cords must always have a protective ground conductor.



CAUTION. *If a unit is moved from a cold to a warm environment, condensation may cause a shock hazard. Allow the instrument several hours to evaporate condensation before use. Make sure that the instrument grounding requirements are strictly met.*



WARNING. *Never interrupt the grounding cord. Any interruption of the protective ground connection inside or outside the instrument or disconnection of the protective ground terminal can result in a shock hazard.*

Orientation and Cooling

You can operate the instrument in any position. Do not obstruct the air flow through the ventilation slots on the side panels: leave 5 centimeters (2 inches) of space on the sides and back of the instrument. The instrument also has fold-down legs for benchtop use.

Getting Acquainted with Your Instrument

Front Panel

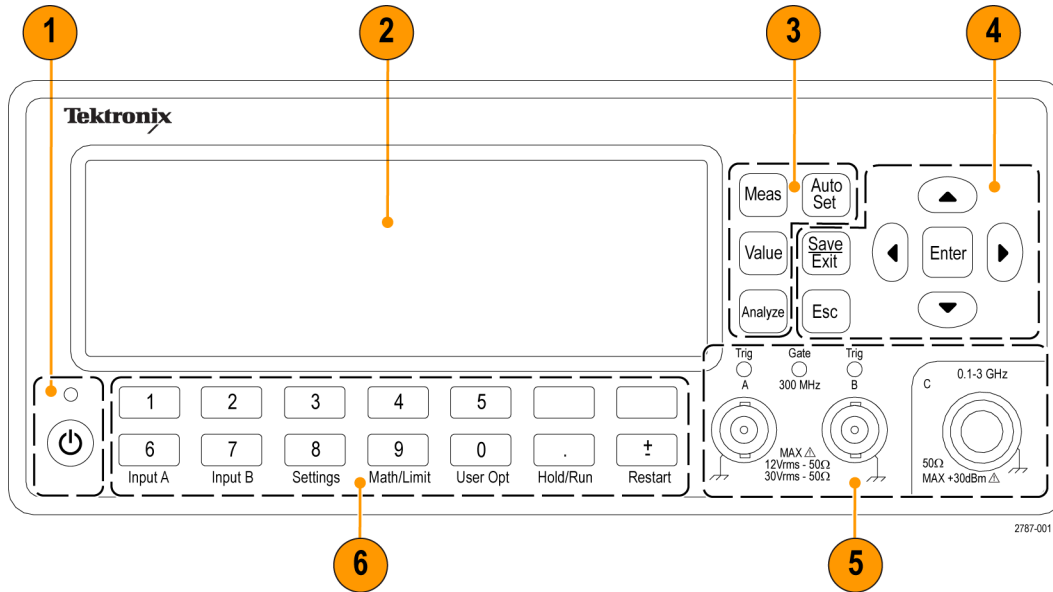

1. Power button (See page 10, *Power Button*.)
2. Main screen (See page 6, *Main Screen*.)
3. Measurement buttons (See page 10, *Measure Button*.)
4. Navigation buttons (See page 11, *Save/Exit Button*.)
5. Input connectors (See page 4, *Input Connectors*.)
6. Keypad buttons (See page 12, *Keypad Buttons*.)

Input Connectors

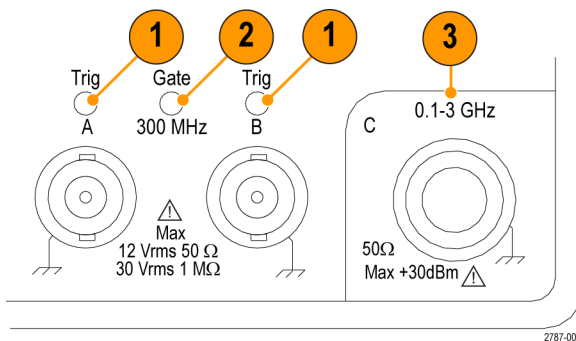

1. Input A and B inputs and trigger indicators. A blinking trigger LED shows correct triggering.
2. Gate indicator. The GATE indicator is on when the counter is busy counting input cycles.
3. Input C prescaler (3 GHz or 20 GHz, FCA3000 and FCA3100 Series) or down converter (27 GHz or 40 GHz, MCA3000 Series) for measuring higher frequencies.

NOTE. Factory Option RP moves the input connectors from the front panel to the rear panel for FCA3000 Series and FCA3100 Series instruments. The Gate and Trig A/B LED indicators remain on the front panel. Option RP is not available on MCA3000 Series instruments.

Rear Panel

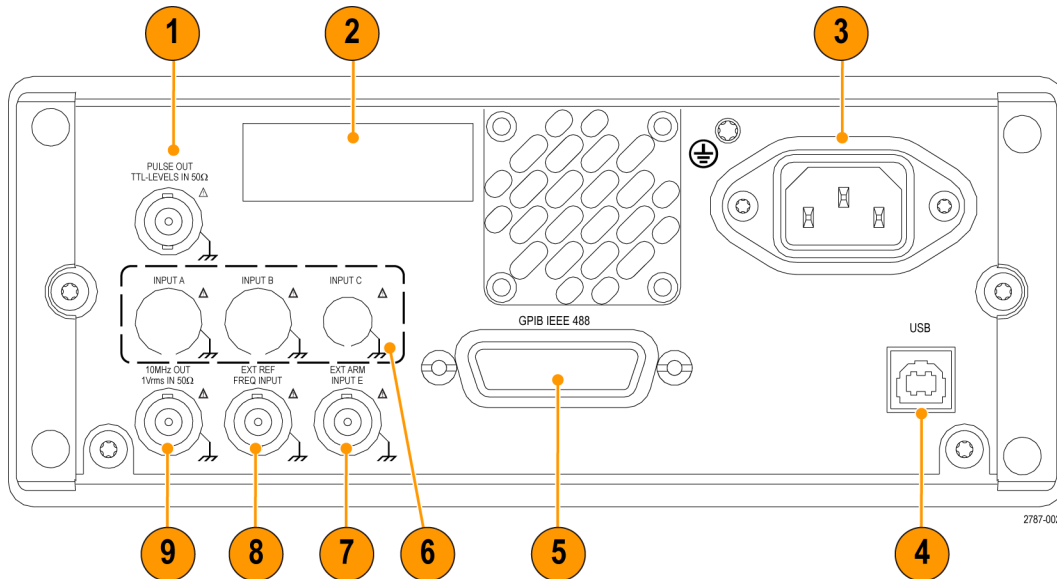

1. Pulse Output connector (FCA3100 Series only).
2. ID label, including model, serial, and installed options numbers.
3. Line power connector.
4. USB 2.0 12 Mb/s port to connect to PC.
5. GPIB port to connect to controller.
6. Optional rear panel input connectors. Factory Option RP moves the front panel input connectors to the rear panel. Not available for MCA3000 Series instruments.
7. External Arm Input connector (for external arming (synchronization) of measurements). You can also select Input A and Input B for measurement arming from the Settings Menu.
8. External Reference Input connector. If the Measurement Reference is set to Auto in the Settings Menu, this input is automatically selected, provided a valid signal is present.
9. 10 MHz Out connector. Provides a reference signal derived from the active measurement reference (internal or external reference). The measurement reference source is set in the Settings Menu.

Main Screen

The instrument uses a monochrome LCD to show signal sources, instrument measurements (numerical and graphical), and menu items. What items are shown depends on the display mode.

Measurement Value Mode

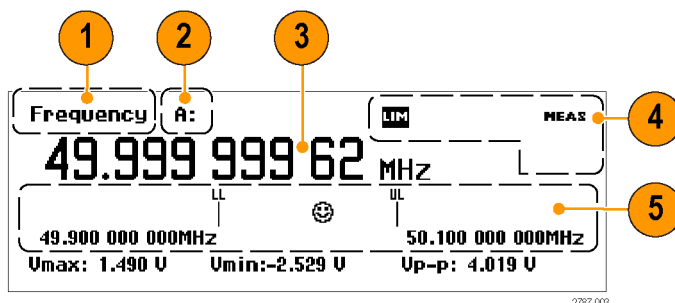

Push the Value button to display a high-resolution numeric readout of the current measurement.

1. The current measurement.
2. The measurement signal source. If the main measurement readout is a statistical measurement, this text also shows the type of statistical measurement (for example, A MEAN:)
3. The main measurement readout. The readout at the bottom of the screen shows electrical information for the source signal. The readouts or display changes depending on the measurement or analysis mode.
4. Measurement status. Shows the math or limit testing mode (MATH or LIM), the measure/hold/single measurement status (MEAS, HOLD, SING), and remote GPIB control status (REM). The measurement status is present in all display modes.

Optional Battery Power (MCA3000 Series only)

The instrument has two battery status indicators near the upper right corner of the screen. One is a battery status indicator and the other is a battery charging level indicator.

The battery status indicator shows:

- A fixed battery symbol when the internal battery is the active power source.
- A charging battery symbol when the internal battery is being charged.
- A power plug symbol when the mains is the active power source.
- A power plug symbol on top of a battery symbol when the instrument has been prepared for UPS operation and charging is not going on.

The charging level indicator shows the relative charge level in percent.

NOTE. Normally the screen shows the active measurement when the instrument is remotely controlled. However, TimeView turns off the screen to speed up measurements: the screen displays the message *Display OFF*, the measurement status is *REM* (remote), and all front panel buttons except *Esc* are disabled. Push the *Esc* button to send a “Return To Local” message to the remote device and return the instrument to local mode.

You cannot use the *Esc* key to return the instrument to local mode if *Local Lockout* was programmed from the remote connection.

- Limit Alarm readout (when enabled). Lower limit (LL) and upper limit (UL) settings are shown as vertical bars with their associated limit value. An emoticon shows the relative measurement value and limit pass/fail state (a smiling face when the measurement is within the limits, and a frowning face when the measurement is outside of the limits). The LIM status text at the top of the screen flashes when the measurement exceeds the limits, and continues to flash even when the measurement is back within limits. Pushing *Restart* resets the LIM status.

Menu Mode

Pushing a menu button (such as *Meas* or any of the lower keypad buttons) replaces the lower screen area with the menu items for that button.

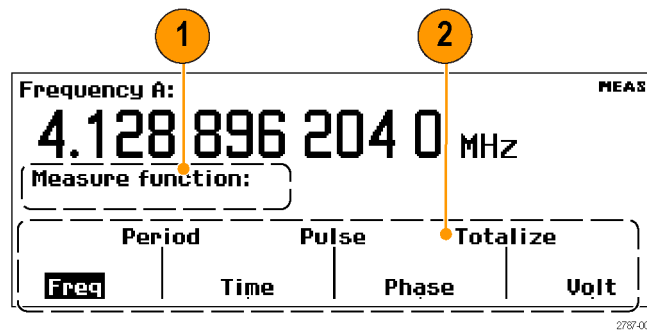

- The Menu path shows the path of the current menu selections.
- The Menu shows the available menu options. Push the keypad button directly below a menu item to select that item and/or open a lower-level menu. The current selection is shown in inverse text. You can also use the Navigation arrow buttons to highlight and select menu items.

Analyze Modes

The Analyze modes (accessible by pushing the *Analyze* button) apply basic statistical analysis to display numerical, histogram, or trend statistical analysis readouts of measurements.

Numerical display. The instrument takes successive measurements and displays the results as numeric statistical readouts.

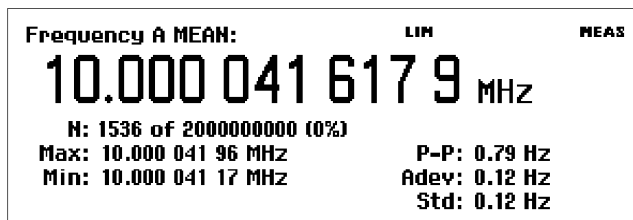

- MEAN: The main measurement shows the running mean value over N samples
- N: The number of measurement samples (set in the Settings > Stat menu)
- Max, Min: The maximum and minimum measurement values
- P-P: Peak-to-peak deviation
- Adev: Allan deviation
- Std: Standard deviation

Histogram display. The instrument displays successive measurements as a histogram. The number of bins along the horizontal axis are set in the Settings > Stat menu.

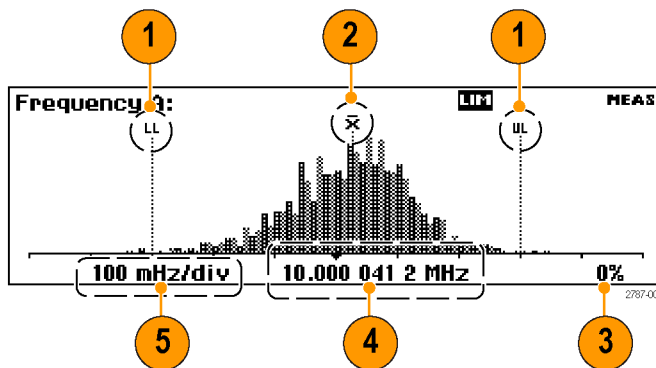

1. The upper and lower Limits Alarm levels (if enabled). When limit testing is active, the instrument autoscales the graph to show both the histogram and the limit. The instrument only uses data inside the limits for autoscaling; measurements outside the visible graph area are shown by an arrowhead at the left or the right edge of the display.
2. The running mean measurement position (\bar{X}).
3. The percent of the measurement completed.

4. The graph center (marked with a dark triangle) and corresponding frequency.
5. The graph horizontal scale per division. Limits Alarm (if active) sets the scale to show both the current measurements and the limit settings. The instrument continually autoscales the histogram bins based on the measured data.

Trend plot display. The instrument takes successive measurements and plots the values over time. This mode is useful for observing fluctuations or measurement deviation trends. A trend plot stops (if HOLD is activated) or restarts (if RUN is activated) after the set number of samples is completed. The trend plot graph continually autoscales based on the measured data, starting with zero at restart. Limit Alarms, if active, are shown as horizontal lines.

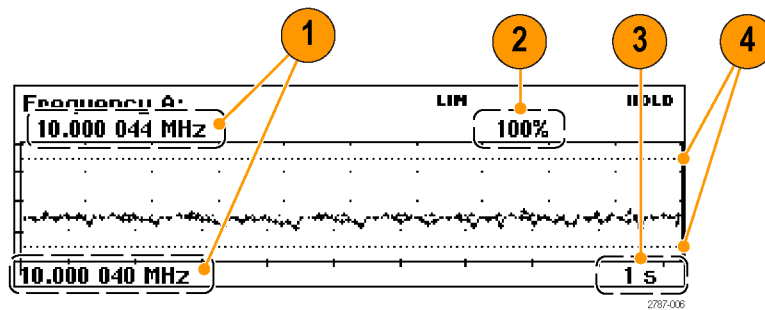

1. The upper and lower frequency range of the plot display. The trend plot graph continually autoscales based on the measured data to show the measurement trend values.
2. The percent of the measurement completed.
3. The horizontal units per division.
4. The Limits Alarm levels (if active). When limit testing is active, the instrument sets the graph scale to show both the measurement trend plot and the limit values (horizontal dashed lines).

Controls

Power Button



Push the **Power** button to power on or off the instrument. The Power button is a secondary power switch; power is applied to some of the instrument as soon as line power is applied, indicated by the red LED above the button. To completely remove power from the instrument, disconnect the power cord.

Measure Button



Use the **Meas** button to display the instrument measurement menu along the bottom of the screen. Press a menu button directly below a menu item to select that menu item and open a sub-menu as needed.

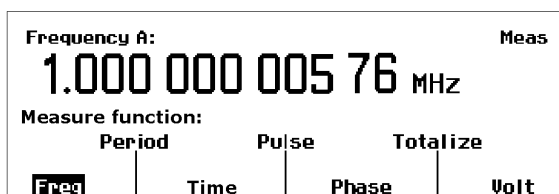

Typical measurements include frequency, period, time, pulse, phase, totalize (FCA3100 Series only), and volts. The measurement menu content depends on the instrument model and configuration.

The current selection is indicated by text inversion (and that also indicates the cursor position). Select the measurement function you want by pushing the corresponding menu softkey below a menu item.

You can also use the **Left** and **Right** arrow buttons to move the cursor and select other menu items. Confirm by pushing **Enter**.

Value Button



Use the **Value** button to display the current measurement as a numerical value. The instrument also displays supplementary measurements along the lower part of the screen.



Analyze Button



Use the **Analyze** button to display the current measurement in one of three statistical analysis display modes. Repeatedly press the Analyze button to cycle through the statistical display modes. (See page 7, *Analyze Modes*.)

Auto Set Button

Use the **Auto Set** button to automatically set trigger levels for the measurement function and input signal amplitude (for relatively normal signals). This enables you to quickly set the instrument to display a measurement.

Pushing the Autoset button once does the following:

- Sets automatic trigger levels
- Sets attenuators to 1x
- Turns on the display
- Sets the Auto Trig Low Freq value to one of the following:
 - 100 Hz, if $f_{in} \geq 100$ Hz
 - f_{in} , if $10 < f_{in} < 100$ Hz
 - 10 Hz, if $f_{in} \leq 10$ Hz

Pushing the Autoset button twice within two seconds performs a more extensive **Preset**. The following parameters are set in addition to the single push Autoset functions:

- Sets **Meas Time** to **200 ms**
- Switches off **Hold-Off**
- Sets **Hold/Run** to **Run**
- Switches off **Math/Limit**
- Switches off **Analog** and **Digital Filters**
- Sets the **Timebase Ref** to **Auto**
- Switches off **Arming**

An even more comprehensive preset function can be performed by recalling the factory default settings.

Save/Exit Button

Use the **Save/Exit** button to confirm the current selection and exit to the previous menu level.

Esc Button

Use the **Esc** button to exit to the previous menu level without confirming the current selection.

Arrow and Enter Buttons

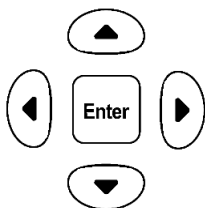

The **Arrow** and **Enter** buttons provide multiple functions depending on the instrument mode:

- **Menu mode:** Use the left-arrow, right-arrow, and Enter buttons to display and select menu items.
- **Numeric entry mode:** Use the left-arrow button to clear the right-most digit in a settings field. Use the up- and down-arrow buttons to increment or decrement a numeric value in a settings field (in a 1-2-5 pattern).
- Use the **Enter** button to accept the displayed value or selected menu item.
- **LCD screen contrast:** Use the up- and down-arrow buttons to set the LCD screen contrast when the instrument is not displaying a menu or prompting for input.

Keypad Buttons

Use the keypad buttons to select menu items, open instrument configuration menus, and enter parameter values.

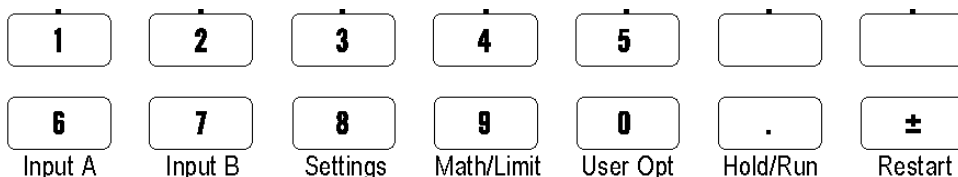

Use the **Numeric** buttons (buttons 0-9, ., and ±) to enter numeric parameter values in parameter fields.

Use the **Menu Softkey** buttons (buttons 1-5 and the two blank buttons on the top row) to select the corresponding screen menu items.

Use the **Menu** buttons (Input A through User Opt, on the bottom row of the keypad) to display the menu for that button.

Input A, Input B. Use the **Input A** and **Input B** buttons to display and configure the input channel settings for the selected channel. The Input A and Input B menu provides channel-related settings, including trigger slope, signal coupling (AC or DC), input impedance (50 Ω or 1 MΩ), input attenuation (1x or 10x), trigger mode (Manual or Auto), Trigger level (when in Manual trigger mode), and Filter (frequency cutoff). The Input A and B menus are identical.

To set a specific trigger level, select the **Manual** trigger mode, select the **Trig** menu item, and use the Navigation arrow buttons to increment/decrement the value. You can also use the numeric buttons and push **Enter** to enter a value.

The Filter Settings menu lets you select a fixed 100 kHz analog filter or an adjustable digital filter. The equivalent cutoff frequency is set using the value input menu that opens if you select Digital LP Frequency from the menu.

NOTE. *Always use Auto trigger level when measuring rise time or fall time.*

Settings. Use the **Settings** button to display the measurement settings configuration menu. The Settings menu provides measurement-related settings, including Measure Time (for frequency measurements), Burst (for pulse-modulated signals), Arming (conditional measurement start/stop), Trigger Holdoff (stop trigger delay), Statistics (settings for statistical measurements), Time base Reference (internal or external), and Miscellaneous (such as input signal timeout period and auto trigger low frequency setting).

Math/Limit. Use the **Math/Limit** button to display the math and limit testing configuration menus. The Math menu provides predefined formulas and user-defined constants to mathematically postprocess the measurement result. A typical use for math processing is to convert a measurement to take into account a mixer or multiplier that is part of the signal under test.

The Limits menu lets you set numerical limits and select how the instrument reports limit violations.

User Opt. Use the **User Opt** button to display the user options configuration menu. The User Options menu provides instrument settings, including saving or recalling instrument setups (up to twenty in nonvolatile memory, each with a unique label), bus interface selection (USB or GPIB), GPIB bus configuration (mode, address), instrument self-tests, conditional output signal setup (FCA3100 Series only), and instrument configuration information (model, serial number, firmware, and configuration).

Hold/Run. Use the **Hold/Run** button to control measurement acquisition. Press the button to toggle between run (constantly acquiring measurements) and hold (measurement pause) modes. The measurement indicator in the upper right corner of the screen changes from MEAS to HOLD when the instrument is in the measurement hold mode. Push the Hold/Run button again to resume the normal (continuous) measurement mode.

To take a single measurement, place the instrument in Hold mode, and then press the Restart button. The measurement indicator in the upper right corner of the screen changes from HOLD to SING when the instrument is taking a single measurement.

Restart. Use the **Restart** button to clear the measurement values and retake a measurement. This is useful when you need to initiate a new measurement after a change in the input signal, especially when using long measuring times. When the instrument is in the Hold mode, use this button to take single measurements.

Restart does not affect any instrument settings.

Entering Numeric Values

Sometimes you might need to enter constants and limits in a menu field. You may also want to select a value that is not in the list of fixed values available by pressing the **Up/Down** arrow buttons, or the value to enter is too far away to reach conveniently by incrementing or decrementing the original value.

To enter numeric values, use the numeric buttons (**0-9**, **.** (decimal point), and **±** (change sign)).

You can also enter values using the scientific notation format. The **EE** (Enter Exponent) softkey lets you toggle between entering the mantissa and the exponent.

Push **Save|Exit** to store the new value or **Esc** to exit this menu without saving the value (retains the current value).

Menus

Input A, Input B Menus

The Input A and Input B menus provides settings for configuring each channel. The contents of the Input A and Input B menus are identical.

Table 1: The Input A, Input B menus

Item	Description
Slope	Trigger on rising or falling edge of a signal.
Signal coupling	AC or DC.
Input impedance	1 M Ω or 50 Ω .
Input signal attenuation	1x or 10x.
Trigger Mode	Sets the signal trigger level mode (Auto or Man). If in Auto trigger mode, use the Trig menu item to set the trigger level manually as a percentage of the amplitude. If in Man trigger mode, use the Trig menu item to enter a trigger value. <i>NOTE. Always use Auto when measuring rise time or fall time.</i>
Trig	Sets the signal trigger level. The value shown is the current trigger level.
Filter	Sets a fixed 100 kHz analog or an adjustable digital cutoff filter. Use the Digital LP Frequency menu to set a specific frequency.

Settings Menu Use the Settings menu to configure the measurement parameters.

Table 2: The Settings menu

Item	Description
Meas Time	Sets the measurement duration. This menu is available for frequency measurements. Longer measuring time means fewer measurements per second and gives higher resolution.
Burst	Sets parameters related to pulse-modulated (burst) signal measurements. The Burst settings menu is available if the selected measurement is Meas > Freq > Freq Burst . Both the carrier frequency and the modulating frequency (the pulse repetition frequency (PRF)) can be measured, often without the support of an external arming signal.
Arm	Sets measurement start and stop parameters. Arming is the general term used for the means to control the actual start and stop time of a measurement. The normal free-running mode is inhibited and triggering takes place when specified pretrigger conditions are detected. The signal or signals used for initiating the arming can be applied to three channels (A, B, or E), and the start channel can be different from the stop channel. All conditions can be set by using this menu.
Trigger Hold Off	Sets the delay during which the stop trigger conditions are ignored after the measurement start. A typical use is to bypass signals generated by bouncing relay contacts.
Stat	Sets statistics measurement parameters: <ul style="list-style-type: none"> ■ The number of samples used for calculation of various statistical measures. ■ The number of bins in the histogram view. ■ Enables Pacing (the delay between measurements) ON or OFF, and sets the delay time from 2 μs – 500 s.
Timebase	Sets an Internal or an External time base reference for measurements. A third alternative is Auto . Then the external time base is selected if a valid signal is present at the reference input. The <i>EXT REF</i> indicator at the upper right corner of the screen shows that the instrument is using an external time base reference.

Table 2: The Settings menu (cont.)

Item	Description
Misc	<p>Sets miscellaneous measurement parameters:</p> <p>Interpolator Calibration enables or disables the instrument interpolator calibration, which increases the measurement speed at the expense of accuracy.</p> <hr/> <p>Smart Measure sets:</p> <ul style="list-style-type: none"> ■ Smart Time Interval (for Time Interval measurements), which uses time stamping to determine which measurement channel precedes the other. ■ Smart Frequency (for Frequency or Period Average measurements), which uses continuous time stamping and regression analysis to increase the resolution for measuring times between 0.2 s and 100 s. <hr/> <p>Timeout enables or disables the timeout function and sets the maximum time the instrument will wait for a pending measurement to finish before outputting a zero result. The range is 10 ms to 1000 s.</p> <hr/> <p>Auto Trig Low Freq sets the lower frequency limit for automatic triggering and voltage measurements within the range 1 Hz to 100 kHz. A higher limit means faster settling time and faster measurements.</p> <hr/> <p>Input C Acq (MCA3000 Series only) sets:</p> <ul style="list-style-type: none"> ■ Acquisition mode to Auto (scan the entire specified frequency range for valid input signals) or Manual (scan a narrow band around a specified center frequency for valid input signals). Manual mode is required when measuring burst signals but is also recommended for FM signals, when the approximate frequency is known. An additional feature of manual mode is that the measurement results are presented much faster, as the acquisition process is skipped. <p>Note that signal frequencies outside the manual capture range may cause wrong results. To draw the operator's attention to this possibility, the instrument shows the indicator M.ACQ in the upper right corner of the screen.</p> <ul style="list-style-type: none"> ■ Freq C Center value. <hr/> <p>TIE (Time Interval Error) (FCA3100 Series only) sets the instrument to choose the reference frequency automatically (Auto) or manually enter a frequency (Manual). TIE measurement uses continuous time-stamping to observe slow phase shifts (wander) in nominally stable signals during extended periods of time.</p>

Math/Limit Menu

The Math/Limit menu provides settings for applying mathematical calculations to a measurement and enabling the instrument to perform limit testing.

Table 3: The Math submenu

Item	Description
Math	Use this menu to select one of five formulas to apply to the measurement result, or select Off to disable the math function. The available formulas are: $K * X + L$ $K / X + L$ $(K * X + L) / M$ $(K / X + L) / M$ $X / M - 1$ K, L, and M are constants that you can set to any value. X stands for the current non-modified measurement result.
K, L, M	Constants in the formulas that you can set to any value.

The Limit submenu lets you set limit testing conditions and limit violation behavior. (See page 71, *Limit Testing*.)

Table 4: The Limit submenu

Item	Description
Limit Behavior	Sets the action the instrument performs when a limit violation is detected, or disables the limit test mode.
Limit Mode	Sets the limit test boundary type (Upper, Lower, or Range).
Lower Limit	Sets the value of the lower limit boundary.
Upper Limit	Sets the value of the upper limit boundary.

User Opt Menu The User Opt menu lets you set general instrument parameters.

Table 5: The User Opt menu

Item	Description
Save/Recall	<p>Save or recall up to twenty instrument configuration setups or eight measurement data sets in nonvolatile memory. Submenu items are:</p> <p>Setup:</p> <ul style="list-style-type: none"> ■ Save Current Setup: Save the current instrument configuration to a specified memory. ■ Recall Setup: Load the current instrument configuration from a selected memory slot into the instrument. Use the Default setup to load the factory default setup into the instrument. ■ Modify Labels: Edit the seven-character label associated with each memory slot. Unique labels make it easier for you to remember the purpose of the setup. ■ Setup Protect: Access to the first ten memory positions is prohibited when Setup Protect is ON. Switching OFF Setup Protect releases all ten memory positions simultaneously. <hr/> <p>Dataset: Save or recall a single statistics measurement (instrument in Hold mode, press Restart to acquire a single measurement). Up to eight data sets can be saved in nonvolatile memory, each containing up to 32000 samples. If the pending measurement has more than 32000 samples, only the last 32000 samples are saved. The instrument assigns a default label to each data set, which you can edit.</p> <ul style="list-style-type: none"> ■ Save: Save the current statistical measurement to the selected memory location. ■ Recall: Loads and displays the selected data set. ■ Erase: Erases the selected data set. <hr/> <p>Total Reset: Restores all factory settings and erases all user information (setups and data sets).</p>
Calibrate	<p>This menu entry is accessible only for factory calibration purposes and is password-protected.</p>
Interface	<p>Sets the active bus interface (GPIB or USB) and associated address information.</p> <p>Bus Type: Select GPIB or USB.</p> <p>GPIB Mode: Select Native (the SCPI command set used in this mode fully exploits all the features of this instrument series) or Compatible (The SCPI command set used in this mode is compatible with Agilent 53131/132/181).</p> <p>GPIB Address: Enter the GPIB instrument number (0–30) for this instrument.</p>
Test	<p>Select and run specific power-on tests.</p> <p>Test Mode: Select an individual instrument self-test, or select all tests.</p> <p>Start Test: Runs the selected test.</p>

Table 5: The User Opt menu (cont.)

Item	Description
Digit Blanks	Sets the number of display digits to mask. Jittery measurement results can be made easier to read by masking one or more of the least significant digits. Use the Up or Down arrow keys to change the number, or enter the desired number (between 0 and 13) from the keypad. The blanked digits are marked by dashes on the screen.
About	Displays instrument information, including model, serial number, instrument firmware version, time base option and calibration date, and the channel C upper frequency limit (for instruments with Channel C option).

Input Signal Conditioning

The instrument provides input amplifiers to adapt the widely varying signals in the ambient world to the measuring logic of the instrument. These amplifiers have many controls, and it is essential to understand how these controls work together and affect the signal.

The following block diagram shows the input signal flow path. It is not a complete technical diagram but is intended to help you understand the controls.

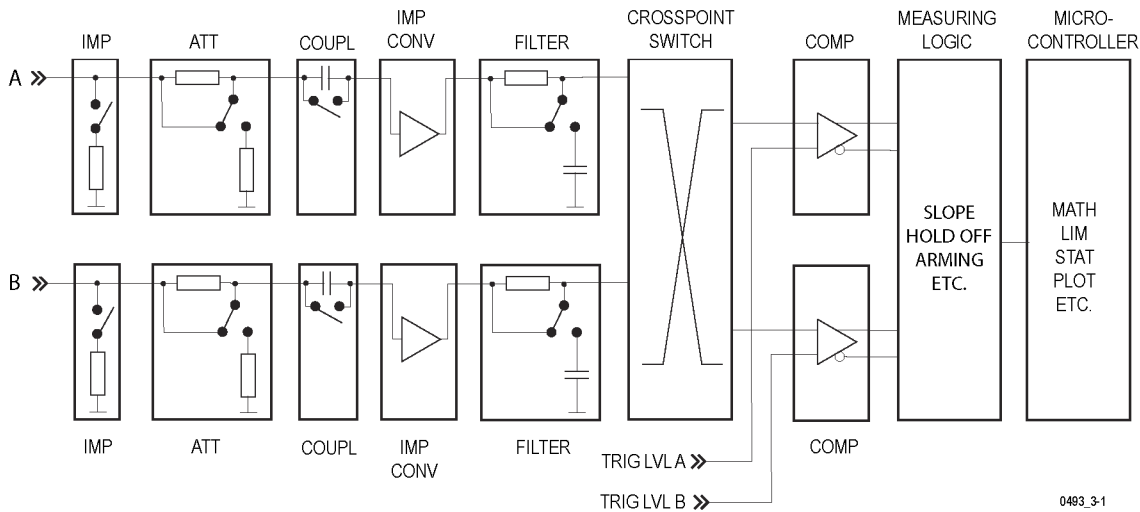

Push the **Input A** or **Input B** menu button to access the input signal controls.

Input Controls

Impedance You can set the input impedance to 1 M Ω or 50 Ω in the corresponding Input A or Input B menu.



CAUTION. Switching the impedance to 50 Ω when the input voltage is above 12 V_{RMS} may cause permanent damage to the input circuitry.

Attenuation You can attenuate the input signal amplitude by 1 or 10 by toggling the menu softkey marked **1x/10x**.

Use attenuation whenever the input signal exceeds the dynamic input voltage range ± 5 V, or when attenuation can reduce the influence of noise and interference. (See page 26, *How to Reduce or Ignore Noise and Interference*.)

Coupling Switch between AC coupling and DC coupling by toggling the softkey **AC/DC**.

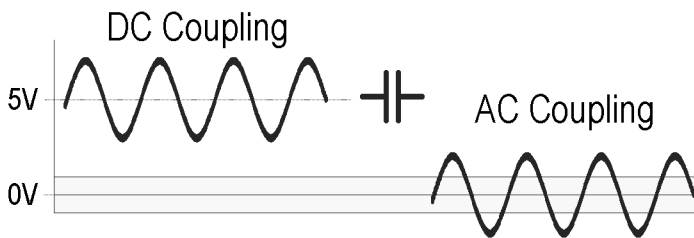

0493_3-3

Use the AC coupling feature to eliminate unwanted DC signal components. Always use AC coupling when the AC signal is superimposed on a DC voltage that is higher than the trigger level setting range. For example, when you measure symmetrical signals, such as sine and square/triangle waves, AC coupling filters out all DC components. This means that a 0 V trigger level is always centered around the middle of the signal where triggering is most stable.

Use DC coupling for signals with a changing duty cycle or with a very low or high duty cycle. The following figures show how pulses can be missed, or that triggering does not occur at all, because the signal amplitude drops below the trigger hysteresis band.

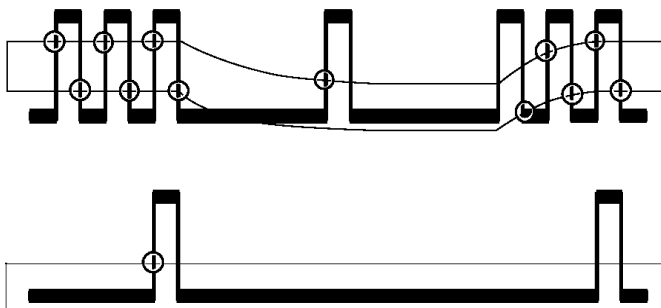

Signal Filters If you cannot obtain a stable reading, the signal-to-noise ratio (often designated S/N or SNR) might be too low, probably less than 6 to 10 dB. Certain conditions call for special solutions like high-pass, bandpass or notch filters, but usually the unwanted noise signals have higher frequency than the signal you are interested in. In that case you can utilize the built-in low-pass filters. There are both analog and digital filters, which you can couple together.



Figure 1: The menu choices after selecting FILTER.

Analog Low-pass Filter. The instrument has analog RC low-pass filters, one each for Input A and B. The cutoff frequency is approximately 100 kHz, and the signal rejection is 20 dB at 1 MHz. Accurate frequency measurements of noisy low-frequency signals (up to 200 kHz) can be made when the noise components have significantly higher frequencies than the fundamental signal.

Digital Low-pass Filter. The Digital LP filter utilizes the Hold-Off function. With trigger Hold-Off it is possible to insert a dead time in the input trigger circuit. This means that the input of the instrument ignores all hysteresis band crossings by the input signal during a preset time after the first trigger event.

When you set the Hold-Off time to approximately 75% of the cycle time of the signal, erroneous triggering is inhibited around the point where the input signal returns through the hysteresis band. When the signal reaches the trigger point of the next cycle, the set Hold-Off time has elapsed and a new and correct trigger is initiated.

Instead of making you calculate a suitable Hold-Off time, the instrument will do the job for you by converting the filter cutoff frequency you enter in the Digital LP Freq menu to an equivalent Hold-Off time.



You should be aware of a few limitations with using the digital filter feature effectively and unambiguously. First you must have a rough idea of the frequency to be measured. A cutoff frequency that is too low might give a perfectly stable reading that is too low. In such a case, triggering occurs only on every 2nd, 3rd, or 4th cycle. A cutoff frequency that is too high (>2 times the input frequency) also leads to a stable reading. Here one noise pulse is counted for each half-cycle.

The cutoff frequency setting range is very wide: 1 Hz – 50 MHz

Use an oscilloscope for verification if you are in doubt about the frequency and waveform of your input signal.

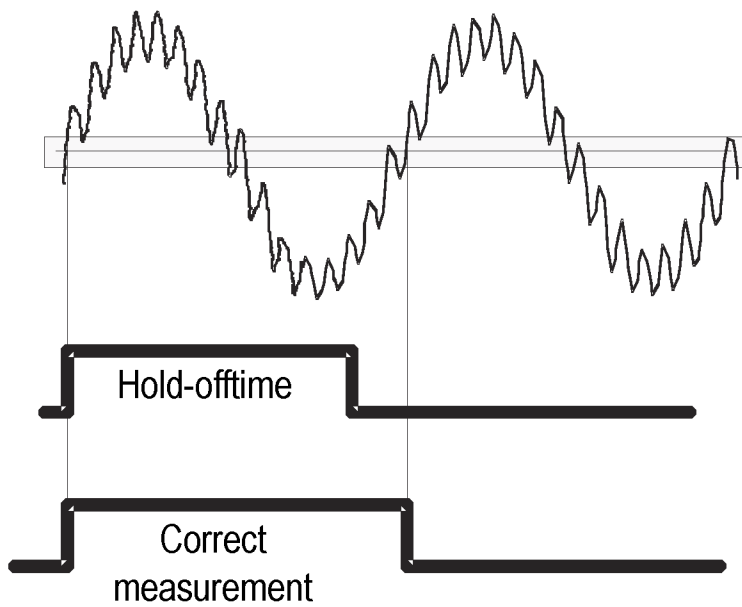

0483_3-8

Figure 2: Digital LP filter operates in the measuring logic, not in the input amplifier.

Trigger Mode (Man/Auto)

This menu item sets the trigger mode. When **Auto** is active the instrument automatically measures the peak-to-peak levels of the input signal and sets the trigger level to 50% of that value. The attenuation is also set automatically.

For rise/fall time measurements the instrument sets the trigger levels to 10% and 90% of the measured peak values.

When **Manual** is active the trigger level is set in the **Trig** menu. The current trigger value is shown below the Trig menu item.

Speeding up measurements. The Auto trigger function measures amplitude and calculates trigger level rapidly, but if you want faster measurement speed without sacrificing the benefits of automatic triggering, then use the **Auto Trig Low Freq** function to set the lower frequency limit for voltage measurement. This menu item is found in **Settings > Misc > Auto Trig Low Freq**.

If you know that the signal you are interested in always has a frequency higher than a certain value f_{low} , then you can enter this value from a value input menu. The range for f_{low} is 1 Hz to 100 kHz, and the default value is 100 Hz. The higher value, the faster the measurement speed due to more rapid trigger level voltage detection.

NOTE. You can use auto trigger on one input and manual trigger levels on the other.

Manual Trigger (Trig)

The Trig menu lets you enter a specific trigger value. Use the arrow buttons to increment or decrement the trigger level value, or use the keypad to enter a specific value. Keep the arrow buttons depressed for faster response.

Setting manual trigger levels speeds up the measurement cycle. Manual triggers do not require the instrument to detect and calculate the trigger levels.

NOTE. *The instrument switches from Auto to Man trigger mode if you enter a trigger level manually.*

NOTE. *You should not use a manual trigger to take measurements of signals with unstable levels.*

Converting an auto trigger level to manual. You can convert the calculated Auto trigger levels into fixed manual trigger levels by switching from **Auto** trigger mode to **Manual** trigger mode. The current calculated auto trigger level (shown under the **Trig** menu item) becomes the new fixed manual level. Subsequent measurements are considerably faster because the instrument does not calculate the trigger levels for each measurement.

NOTE. *You can use auto trigger on one input and manual trigger levels on the other.*

How to Reduce or Ignore Noise and Interference

The instrument input circuits are sensitive to noise. Matching the input signal amplitude and noise characteristics to the instrument's input sensitivity (trigger levels) reduces the risk of wrong counts from noise and interference. For example, an incorrect trigger level with a narrow hysteresis can cause incorrect counts on variable-level signals, as shown in the following figure.

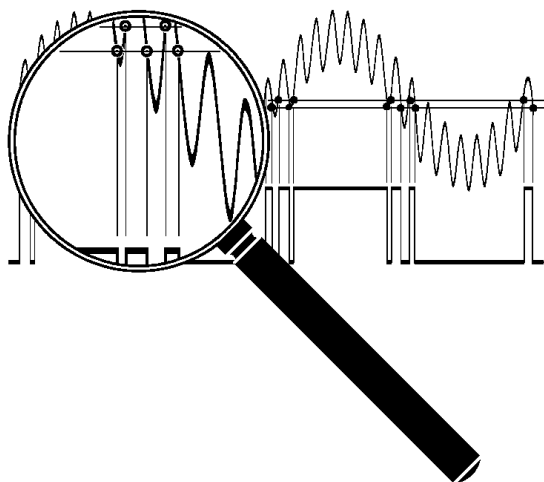

A wider trigger hysteresis provides correct triggering and measurements on variable-level and noisy signals.

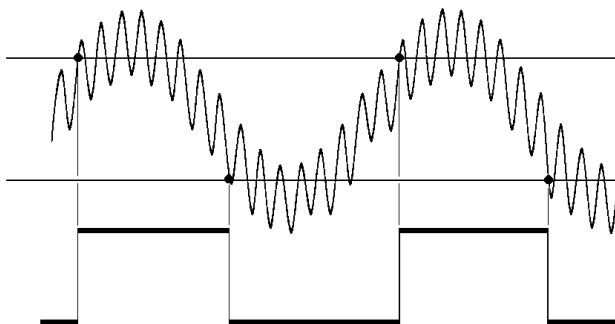

Use the following functions to reduce or eliminate the effect of noise and improve measurement results:

- 10x input attenuator
- Continuously variable trigger level (Auto trigger)
- Continuously variable hysteresis for some functions
- Analog low-pass noise suppression filter
- Digital low-pass filter (Trigger Hold-Off)

You can use several of the above techniques simultaneously to make reliable measurements possible on very noisy signals.

Optimizing the input amplitude and trigger level, and using the attenuator and the trigger control, is independent of input frequency and useful over the entire frequency range. LP filters, on the other hand, function selectively over a limited frequency range.

Trigger Hysteresis

The signal needs to cross the 20 mV input hysteresis band before triggering can even occur. This minimum trigger hysteresis prevents the input circuit from self-oscillating and reduces its sensitivity to noise. Other names for trigger hysteresis are trigger sensitivity and noise immunity.

Lower-level noise on a signal can also affect the trigger point by advancing or delaying it, even if the noise does not cause incorrect counts. This trigger uncertainty is of particular importance when measuring low frequency signals, since the signal slew rate (in V/s) is low for LF signals.

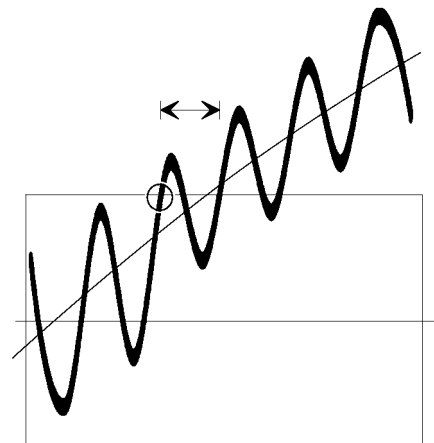

To reduce trigger uncertainty, the signal needs to cross the hysteresis band as fast as possible (high slew rate). A high amplitude signal passes the trigger hysteresis band faster than a low amplitude signal. For low frequency measurements where the trigger uncertainty is of importance, do not attenuate the signal too much, and set a high instrument sensitivity level.

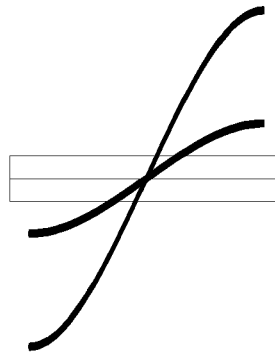

Wrong counts caused by trigger errors are much more common. To avoid incorrect counting caused by spurious signals, reduce input signal amplitudes. This is particularly true when measuring on high impedance circuitry and when using 1 M Ω input impedance. Under these conditions, the cables easily pick up noise.

External attenuation and the internal 10x attenuator reduce the signal amplitude, including the noise, while the internal sensitivity control in the instrument reduces the instrument's sensitivity, including sensitivity to noise. To reduce excessive signal amplitudes, use the built-in 10x attenuator, an external coaxial attenuator, or a 10x probe.

How To Use Trigger Level Settings

For most frequency measurements, the optimal triggering is obtained by positioning the mean trigger level at mid amplitude, using either a narrow or a wide hysteresis band, depending on the signal characteristics.

When measuring low-noise LF sine wave signals, use a high sensitivity (narrow hysteresis band) to reduce the trigger uncertainty. Triggering at or close to the middle of the signal leads to the smallest trigger (timing) error since the signal slope is steepest at the sine wave center.

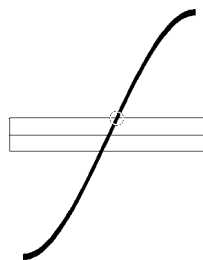

When you have to avoid wrong counts due to noisy signals, expanding the hysteresis window gives the best result if you still center the window around the middle of the input signal. The signal excursions beyond the hysteresis band should be equal.

Auto trigger. For normal frequency measurements, that is without arming, the Auto Trigger function changes to *Auto (Wide) Hysteresis*, which widens the hysteresis window to between 70% and 30% of the peak-to-peak amplitude.

This is done with a successive approximation method to determine the signal minimum and maximum trigger levels (the levels where triggering just stops). The instrument then sets the hysteresis levels to the calculated values. The default relative hysteresis levels are indicated by 70% on Input A and 30 % on Input B. These values can be manually adjusted between 50% and 100% on Input A and between 0% and 50% on Input B. The signal, however, is only applied to one channel.

The instrument normally repeats the signal trigger level detection process for each frequency measurement to identify new trigger and hysteresis values. A prerequisite to enable Auto triggering is therefore that the input signal is repetitive. Another condition is that the signal amplitude does not change significantly after the measurement has started.

Auto trigger also reduces the maximum measuring rate when an automatic test system makes many measurements per second. To increase the measuring rate, push the Auto Set button once to set the trigger level manually based on the values calculated by the Auto level mode.

Manual trigger. Switching to **Man Trig** also means *Narrow Hysteresis* at the last Auto level. Pushing **Auto Set** once starts a single automatic trigger level calculation (*Auto Once*). This calculated value, 50% of the peak-to-peak amplitude, is the new fixed trigger level, from which you can make manual adjustments if required.

Harmonic distortion. As rule of thumb, stable readings are free from noise or interference. However, stable readings are not necessarily correct; harmonic distortion can cause incorrect yet stable readings.

Sine wave signals that contain harmonic distortion, such as those in the following graphics, can be measured by setting correct trigger levels (Manual mode) or by using continuously variable sensitivity (Auto mode). You can also use Trigger Hold-Off to position the trigger point to a specified point on the signal and improve results.

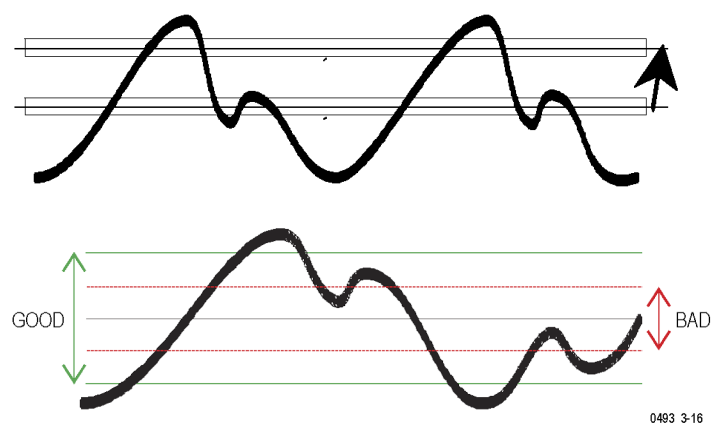

Frequency Measurements

Theory of Measurement

Reciprocal Counting

The FCA3000, FCA3100, and MCA3000 Series instruments use a high-resolution reciprocal counting technique that synchronizes the measurement start with the input signal. This results in an exact number of integral input cycles to count.

Reciprocal counting is a significant improvement over simple frequency counters that count the number of input cycles during a preset, nonsynchronized gate time. Simple gated counting can result in a ± 1 input cycle count error, especially for low-frequency measurements.

After the start of the set measurement time, the instrument synchronizes the beginning of the actual gate time with the first trigger event (t_1) of the input signal.

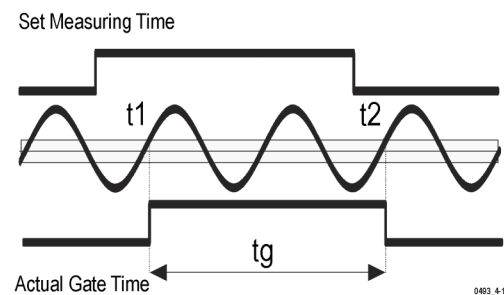

In the same way, the instrument synchronizes the stop of the actual gate time with the input signal, after the set measurement time has elapsed. The multi-register counting technique allows you to simultaneously measure the actual gate time (t_g) and the number of cycles (n) that occurred during this gate time.

Thereafter, the instrument calculates the frequency according to:

$$f = \frac{n}{t_g}$$

The instrument measures the gate time, t_g , with a resolution of 100 ps, independent of the measured frequency. So the use of prescalers does not influence the quantization error. Therefore, the *relative* quantization error is 100 ps/ t_g .

For a 1-second measurement time, this value is:

$$\frac{100 \text{ ps}}{1 \text{ s}} = 100 \times 10^{-12} = 1 \times 10^{-10}$$

Except for very low frequencies, t_g and the set measurement time are nearly identical.

Sample-Hold

If the input signal disappears during the measurement, the instrument will behave like a voltmeter with a sample-and-hold feature and will freeze the result of the previous measurement.

Time-Out Mainly for GPIB use, you can manually select a fixed time-out in the menu reached by pressing **Settings > Misc > Timeout**. The range of the fixed time-out is 10 ms to 1000 s, and the default setting is **Off**.

Select a time that is longer than the cycle time of the lowest frequency you are going to measure; multiply the time by the prescaling factor of the input channel and enter that time as time-out.

When no triggering has occurred during the time-out, the instrument will show NO SIGNAL.

Measuring Speed The set measurement time determines the measuring speed for the Period Average and Frequency measurements. For continuous signals:

$$Speed \approx \frac{1}{t_g + 0.2} \text{ readings/s}$$

when Auto trigger is on and can be increased to:

$$Speed \approx \frac{1}{t_g + 0.001} \text{ readings/s}$$

when Manual trigger is on, or using GPIB:

$$Speed \approx \frac{1}{t_g + 0.00012} \text{ readings/s}$$

Average and single cycle measurements. To reduce the actual gate time or measuring aperture, the counters have very short measurement times and a mode called **Single** for period measurements. The latter means that the instrument measures during only *one cycle* of the input signal. In applications where the instrument uses an input channel with a prescaler, the **Single** measurement will last as many cycles as the division factor. If you want to measure with a very short aperture, use an input with a low division factor.

Averaging is the normal mode for frequency and period measurements when you want to reach maximum resolution. There is always a tradeoff between time and precision, however, so decide how many digits you need and use as short a measurement time as possible to arrive at your objective.

Prescaling may influence measurement time (FCA3003, FCA3020, FCA3103, FCA3120). Prescalers do affect the minimum measurement time, because short bursts have to contain a minimum number of carrier wave periods. This number depends on the prescaling factor.

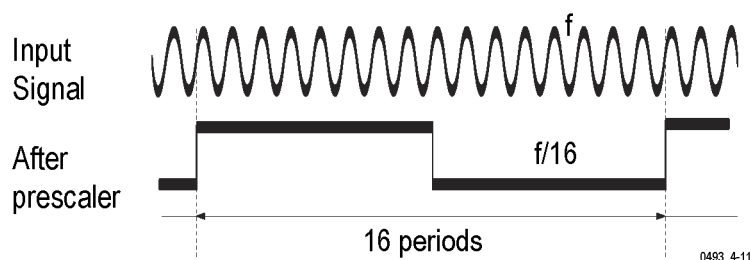

Figure 3: Divide-by-16 prescaler.

The figure shows the effect of the 3 GHz prescaler. For 16 input cycles, the prescaler gives one square wave output cycle. When the instrument uses a prescaler, it counts the number of prescaled output cycles, such as $f/16$. The display shows the correct input frequency since the instrument compensates for the effect of the division factor d as follows:

$$f = \frac{n \times d}{t_g}$$

Prescalers do not reduce resolution in reciprocal counters. The relative quantization error is still:

$$\frac{100 \text{ ps}}{t_g}$$

Use the following table to find the prescaling factors used in different measurement modes:

Table 6: Measurement prescaling factors

Function	Prescaling factor
Freq A/B (300 MHz)	2
Burst A/B (<160 MHz)	1
Burst A/B (>160 MHz)	2
Period A/B AVG (300 MHz)	2
Period A/B SGL (300 MHz)	1
Freq C (3 GHz)	16
Freq C (20 GHz)	128

LF signals. Signals below 100 Hz should be measured with manual triggering unless the default setting (100 Hz) is changed. (See page 16.) The low limit can be set to 1 Hz, but the measurement process is slowed down considerably if auto triggering is used with very low frequencies.

When measuring pulses with a low repetition rate, such as a 0.1 Hz pulse with a nonprescaled measurement like Period Sgl, the measurement requires at least the duration of one cycle, that is 10 seconds, and at worst nearly 20 seconds. The worst case is when a trigger event took place just before the beginning of a measurement time, as shown in the following figure. Measuring the frequency of the same signal will take twice as long, since this function involves prescaling by a factor of two. Even if you enter a short measurement time for this example, the instrument will require 20 – 40 seconds to take the measurement.

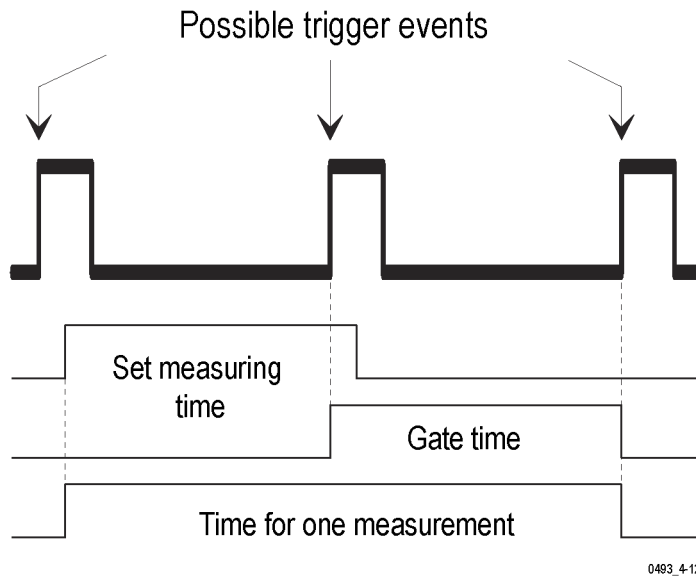

RF signals (FCA3003, FCA3020, FCA3103, FCA3120). The C-input prescaler divides the input frequency before it is counted by the normal digital counting logic. The division factor is called *prescaler factor* and can have different values depending on the prescaler type. The 3 GHz prescaler is designed for a prescaling factor of 16. This means that an input C frequency of, for example, 1.024 GHz is transformed to 64 MHz.

Prescalers are designed for optimum performance when measuring stable continuous RF. Most prescalers are inherently unstable and would self-oscillate without an input signal. To prevent a prescaler from oscillating, a “Go-detector” is incorporated. The Go-detector continuously measures the level of the input signal and blocks the prescaler output when no signal, or a signal that is too weak, is present.

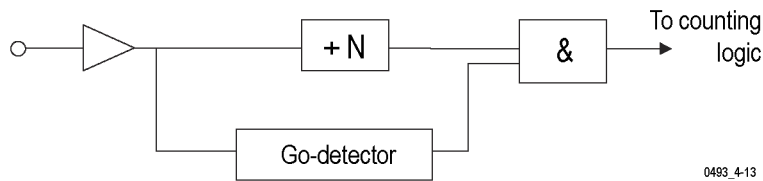

Figure 4: Go-detector in the prescaler.

The presence of a burst signal to be measured makes certain demands upon the signal itself. Regardless of the instrument's ability to measure during very short measurement times, the burst duration must meet the following minimum conditions:

$$Burst_{min} > (presc.factor) \times (inp.cycle\ time) \times 3$$

Normally the real minimum limit is set by other factors, like the speed of the Go-detector. This speed depends on the specific input option used.

Measuring microwaves (FCA3020, FCA3120, MCA3027, and MCA3040). Measuring frequencies up to 20 GHz is possible on the FCA3020 and FCA3120 instruments, which include 20 GHz prescalers.

The MCA3027 and MCA3040 let you measure frequencies up to 27 GHz and 40 GHz, respectively, using down converters. Down converters mix the unknown input signal with a known local oscillator (LO) frequency until there is a signal present within the passband of the IF amplifier (in this case 10 – 200 MHz). (See Figure 5.)

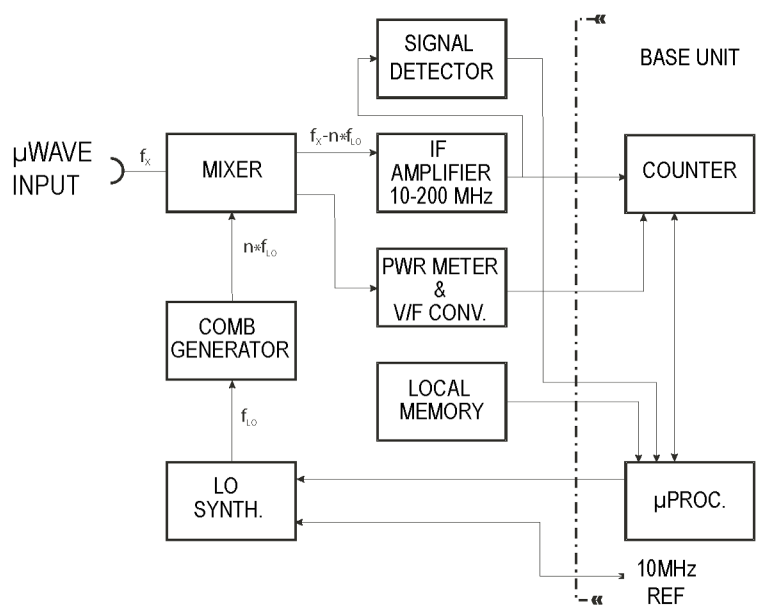

Figure 5: Microwave acquisition in the MCA3000 Series.

The basic LO frequency range is 430 – 550 MHz and is divided into several discrete frequencies fetched from a look-up table. The LO output is fed to a comb generator that creates a harmonic spectrum covering the whole specified microwave range.

The automatic process of calculating the input frequency consists of the following steps:

1. **Preacquisition:** This process detects if there is a measurable signal present at the input and determines the LO frequency that will provide an IF signal above a certain threshold level. This is done by sequentially stepping the LO from the highest value in the look-up table to the lowest value and applying the resulting comb generator spectrum to the mixer. The process is stopped when the signal detector outputs a status signal to the processor.
2. **Acquisition:** This process determines the harmonic needed to generate the IF signal. The instrument measures the IF, decreases the LO frequency by 1 MHz, and measures the IF again. By examining the value and sign of the difference between the two measurements, the instrument can determine if the original IF should be added to or subtracted from the calculated harmonic to arrive at the final value. For example, if the difference between the two values is 5 MHz, then the instrument knows that the fifth harmonic is the origin.
3. **Final RF calculation:** The instrument knows the LO frequency, the multiplication factor n and the sign. The instrument counts the IF during a measurement time corresponding to the desired resolution and uses the result to calculate the final value to display as:

$$f_x = n \times f_{LO} \pm IF$$

There are several conditions that can complicate the acquisition process. All of them are handled by measures taken by the instrument firmware. For example:

- One of the step frequencies produces an IF but not its shifted value. The instrument goes to the next table value.
- Frequency modulation causes an unstable ‘n’ value calculation. The instrument increases the measuring time.

Power measurement. The MCA3027 and MCA3040 instruments can measure microwave signal power over the entire range of the Input C down-converter. Frequency-dependent power measurement correction data stored in the down converter help improve measurement readings.

Input A, B

Menu path: **Meas > Freq.**

Frequency is measured as the inverse of the time between one trigger point and the next within the hysteresis band. The instrument measures frequencies between 100 Hz and 300 MHz on Input A and Input B.

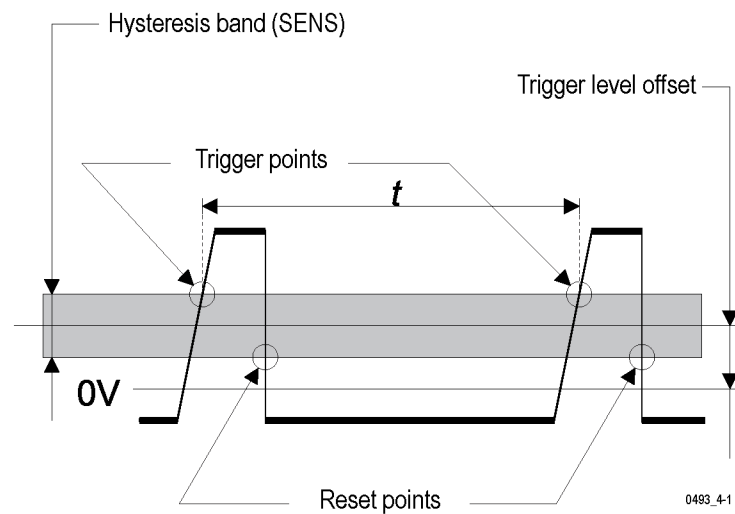

Frequencies above 100 Hz are best measured using the *Default Setup*. (See page 85, *Default Instrument Settings*.) Then **Freq A** is selected automatically. Other important automatic settings are **AC Coupling**, **Auto Trig** and **Meas Time 200 ms**. The default settings provide a successful starting point for frequency measurements.

The following is a list of settings to use for optimum frequency measurements:

- *AC Coupling*, because possible DC offset is normally undesirable.
- *Auto Trig* means *Auto Hysteresis* in this case, (comparable to AGC) because superimposed noise exceeding the normal narrow hysteresis window is suppressed.
- *Meas Time 200 ms* to get a reasonable trade off between measurement speed and resolution.

Some of the settings made above by recalling the *Default Setup* can also be made by activating the **Auto Set** button. Pushing it once means:

- *Auto Trig*. Note that this setting is made once only if *Man Trig* was selected earlier.

Pushing **Auto Set** twice within two seconds also sets the measurement time to 200 ms.

Input C

FCA3X00 Series Instruments

The Input C prescaler in applicable FCA3X00 Series instruments lets you measure up to 20 GHz. The Input C prescaler is fully automatic and no setup is required.

MCA3000 Series Instruments

The MCA3000 Series instruments measure RF frequencies up to 27 GHz or 40 GHz by means of an automatic down-conversion technique. (See page 35, *Measuring microwaves (FCA3020, FCA3120, MCA3027, and MCA3040).*) Faster (manual) acquisition is an alternative if you know the approximate measured frequency. Enter the frequency as a starting point for the acquisition process.

An additional feature is measuring signal power with high resolution.

Ratio A/B, B/A, C/A, C/B

Menu path: **Meas > Freq Ratio.**

To find the ratio between two input frequencies, the instrument counts the cycles on two channels simultaneously and divides the result on the primary channel by the result on the secondary channel. Ratio can be measured between Input A and Input B, where either channel can be the primary or the secondary channel. Ratio can also be measured between Input C and Input A or between Input C and Input B, where Input C is the primary channel.

Burst A, B, C

Menu path: **Meas > Freq Burst.**

A burst signal has a carrier wave (CW) frequency and a modulation frequency, also called the pulse repetition frequency (PRF), that switches the CW signal on and off.

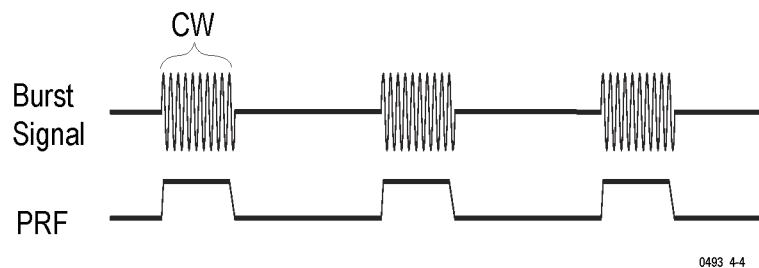

Both the CW frequency, the PRF, and the number of cycles in a burst are measured without external arming signals and with or without selectable start arming delay. (See page 73, *Arming.*)

The general frequency limitations for the respective measuring channel also apply to burst measurements. The minimum number of cycles in a burst on Input A or Input B is 3 below 160 MHz and 6 between 160 MHz and 300 MHz. Burst measurements on Input C involve prescaling, so the minimum number of cycles is $3 \times \text{prescaling factor}$. For example, the 3 GHz model has a prescaling factor of 16 and therefore requires at least 48 cycles in each burst.

The minimum burst duration is 40 ns below and 80 ns above 160 MHz.

Burst and Triggering

Bursts with a PRF above 50 Hz can be measured with auto triggering on.

Out-of-sync errors may occur more frequently when using Auto trigger. (See page 41, *Possible burst measurement errors*.)

When PRF is below 50 Hz and when the gap between the bursts is very small, use manual triggering.

Always try using **Auto Set** first. The *Auto Trigger* and the *Auto Sync* functions in combination will give satisfactory results in most cases. Sometimes switching from **Auto** to **Manual** triggering in the **Input A/B** menus can produce more stable readings.

Input C has always automatic triggering and **Auto Set** only affects the burst synchronization.

Burst Measurements Using Manual Presetting

Three time values must be set to measure the correct part of a burst; Measure Time, Sync Delay, and Arm Start Delay.

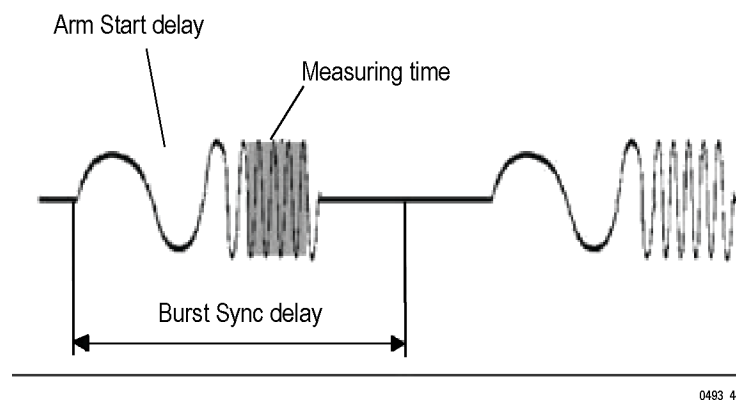
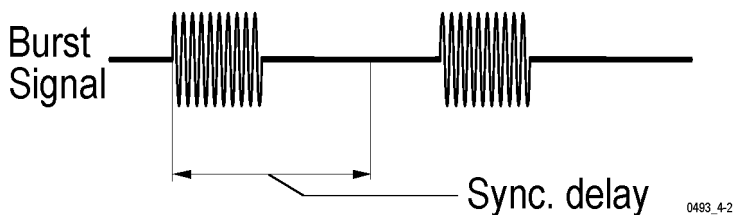

Figure 6: Three time values must be set to measure the correct part of a burst

You can measure the frequency on Input A and Input B to 300 MHz, and on Input C with limited specifications to the upper frequency limit of the prescaler with the internally synchronized BURST function as follows:

1. Push **Meas > Freq > Freq Burst**.
2. Select the input source **A, B, or C**.

3. Push **Settings > Burst**.
4. Push **Meas Time** and enter a measurement time value that is shorter than the burst duration minus two CW cycles. If you do not know the approximate burst parameters of your signal, always start with a short measurement time and increase it gradually until the readout gets unstable.
5. Push **Sync Delay** and enter a value longer than the burst duration and shorter than the inverse of the PRF.



6. Push **Start Delay** and enter a value longer than the transient part of the burst pulse.
7. Select **Frequency Limit** (160/300 MHz) if Input A or Input B is to be used. Use the low limit if possible to minimize the number of cycles necessary to make a measurement.
8. Push **Save|Exit** to display the measurement.

The instrument displays all relevant burst measurements.

Selecting measurement time. The measurement time must be shorter than the duration of the burst. If the measurement continues during part of the burst gap, no matter how small a period of time, then the measurement is ruined. Choosing a measurement time that is too short is better since it only reduces the resolution. Making burst frequency measurements on short bursts means using short measurement times, giving a poorer resolution than normally achieved with the instrument.

How sync delay works. The sync delay works as an internal start arming delay; it prevents the start of a new measurement until the specified sync delay time has expired.

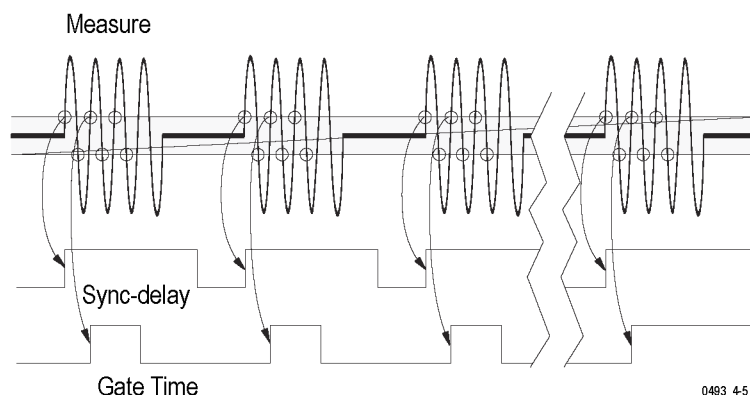

After the set measurement time has started, the instrument synchronizes the start of the measurement with the second trigger event in the burst. This means that the measurement does not start erroneously during the Burst Off duration or while inside the burst.

Possible burst measurement errors. Before the measurement is synchronized with the burst signal, the first measurement(s) could start accidentally during the presence of a burst. If this would happen and if the remaining burst duration is shorter than the set measurement time, the readout of the first measurement will be wrong. However, after this first measurement, a properly set start-arming sync delay time will synchronize the next measurements.

In manually operated applications, this is not a problem. In automated test systems where the result of a single measurement sample must be reliable, at least two measurements must be made, the first to synchronize the measurement, and the second from which the measurement result can be read out.

Frequency Modulated Signals

A frequency modulated signal is a carrier wave signal (CW frequency = f_0) that changes in frequency to values higher and lower than the frequency f_0 . It is the modulation signal that changes the frequency of the carrier wave.

The instrument can measure:

f_0 = Carrier frequency (Frequency).

f_{\max} = Maximum frequency (MAX).

f_{\min} = Minimum frequency (MIN).

Δf = Frequency swing = $f_{\max} - f_0$ (P-P).

Frequency f_0

To determine the carrier wave frequency, measure f_{mean} which is a close approximation of f_0 .

1. Push **Analyze** to get an overview of all the statistical parameters.
2. Select the measurement time so that the instrument measures an even number of modulation periods. This way the positive frequency deviations will compensate the negative deviations during the measurement.

For example, if the modulation frequency is 50 Hz and the measurement time 200 ms, the instrument takes 10 complete modulation cycle measurements.

If the modulation is non-continuous, like a voice signal, it is not possible to fully compensate positive deviations with negative deviations. In this case, part of a modulation swing may remain uncompensated for, and result in a measurement that is too high or too low.

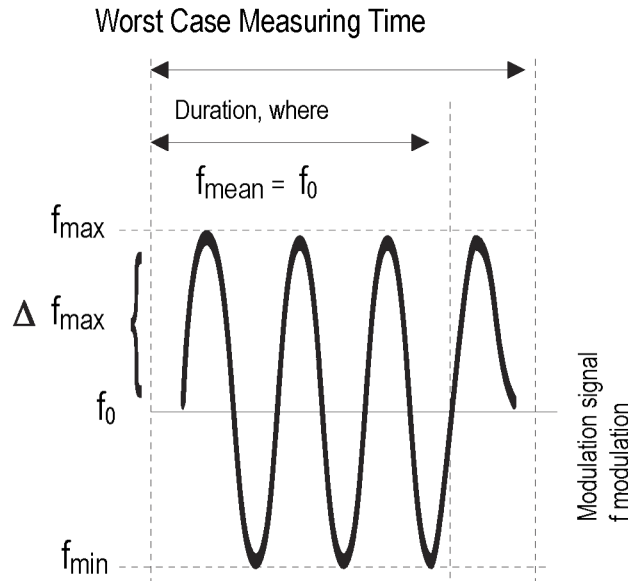

0493_4-6

Figure 7: Frequency modulation

In the worst case, exactly half a modulation cycle would be uncompensated for, giving a maximum uncertainty of:

$$f_0 - f_{mean} = \pm \frac{\Delta f_{max}}{t_{measuring} \times f_{modulation} \times \pi}$$

For very accurate measurements of the carrier wave frequency f_0 , measure on the unmodulated signal if it is accessible.

Modulation frequencies above 1 kHz.

1. Turn off **Single**.
2. Set a long measurement time that is an even multiple of the inverse of the modulation frequency. You will get a good approximation when you select a long measurement time, for instance 10 s, and when the modulation frequency is high, above 1000 Hz.

Low modulation frequencies.

1. Push **Settings > Stat** and set the **No. of samples** parameter to as large a value as possible considering the maximum allowed measurement time.
2. Push **Analyze** and let the instrument calculate the mean value of the samples.

You will usually get good results with 0.1 s measurement time per sample and more than 30 samples ($n \geq 30$). You can try out the optimal combination of sample size and measurement time for specific cases. It depends on the actual f_0 and Δf_{max} .

Here the sampling frequency of the measurement (1/measurement time) is asynchronous with the modulation frequency. This leads to individual measurement results which are randomly higher and lower than f_0 . The statistically averaged value of the frequency f_{mean} approaches f_0 when the number of averaged samples is sufficiently large.

When the instrument measures instantaneous frequency values (when you select a very short measurement time), the RMS measurement uncertainty of the measured value of f_0 is:

$$f_0 - f_{mean} = \pm \frac{1}{\sqrt{2n}} \times \Delta f_{max}$$

where n is the number of averaged samples of f.

fmax (MAX)

To measure fmax:

1. Push **Settings > Stat** and set **No.of samples** to 1000 or more.
2. Push **Meas Time** and select a low value.
3. Push **Analyze**; the instrument displays f_{max} in the MAX readout.

fmin (MIN)

1. Push **Settings > STAT** and set **No.of samples** to 1000 or more.
2. Push **Meas Time** and select a low value.
3. Push **Analyze**; the instrument displays f_{min} in the MIN readout.

- Δf_{p-p} (P-P)
1. Push **Settings** > **Stat** and set **No.of samples** to 1000 or more.
 2. Push **Meas Time** and select a low value.
 3. Push **Analyze** and read P-P.

$$\Delta f_{p-p} = f_{max} - f_{min} = 2 \times \Delta f$$

Errors in f_{max} , f_{min} , and Δf_{p-p} .

A measurement time corresponding to 1/10 cycle, or 36° of the modulation signal, leads to an error of approximately 1.5%.

Select the measurement time such that:

$$t_{measure} \leq \frac{1}{10 \times f_{modulation}}$$

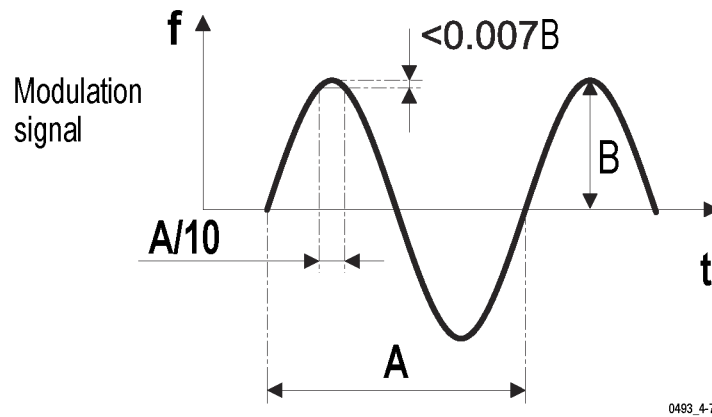

Figure 8: Error when determining f_{max}

To be confident that the captured maximal frequency really is f_{max} , select a sufficiently large number of samples, such as $n \geq 1000$.

AM Signals

The instrument can usually measure both the carrier wave frequency and modulation frequency of AM signals. These measurements are much like the burst measurements described earlier in this manual.

Measuring the Carrier Wave Frequency

The carrier wave (CW) is only continuously present in a narrow amplitude band in the middle of the signal if the modulation depth is high. If the trigger sensitivity (hysteresis) of the instrument is too wide, triggering will miss some cycles and the measurement results will be incorrect.

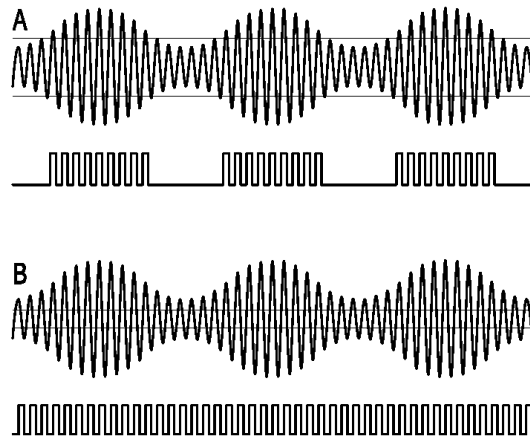

To measure the CW frequency:

1. Push the **Input A** menu button.
2. Select a measurement time that gives you the resolution you want.
3. Enable **Manual** trigger.
4. Push **Trig** level and enter **0 V** trigger level and **Save|Exit**.
5. Select **AC** coupling.
6. Select **1x** attenuation to get a narrow hysteresis band. If the instrument triggers on noise, widen the hysteresis band with the 'variable hysteresis' function, that is enter a trigger level >0 V but $< V_{P-Pmin}$.

Measuring the Modulating Frequency

The easiest way to measure the modulating frequency is after demodulation, for instance by using an RF-detector probe (also known as a demodulator probe) with AC coupling on the input channel.

If no suitable demodulator is available, use the **Freq Burst** function to measure the modulation frequency in the same way as when measuring Burst PRF.

To measure the modulating frequency:

1. Push **Meas > Freq Burst A**.
2. Push **Settings > Burst > Meas Time** and enter a measurement time that is approximately 25% of the modulating period.
3. Push **Sync Delay** and enter a value that is approximately 75% of the modulating period.
4. Push **Input A** and turn on **Manual** trigger.

5. Push **Trig** and enter a trigger level that makes the instrument trigger according to the following figure.

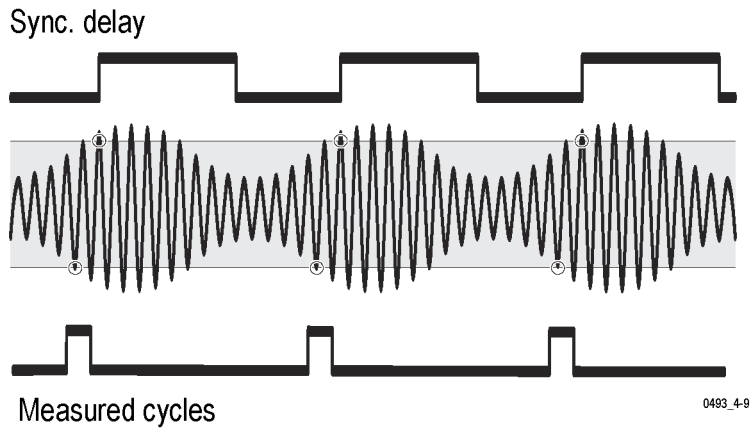

The **PRF** readout shows the modulating frequency even though the main frequency reading may be unstable.

Period

Single A, B and Avg. A, B, C

Menu path: **Meas > Period > Single**.

From a measuring point of view, the period function is identical to the frequency function. This is because the period of a cyclic signal has the reciprocal value of the frequency $1/f$.

In practice there are two minor differences.

1. The instrument calculates frequency (always average) as:

$$f = \frac{\text{number of cycles}}{\text{actual gate time}}$$

while it calculates period averages as:

$$p = \frac{\text{actual gate time}}{\text{number of cycles}}$$

2. The instrument does not use a prescaler for Single Period measurements.

All other functions and features as described earlier for Frequency measurements apply to Period measurements.

Single A, B Back-to-Back (FCA3100 Series Only)

Menu path: **Meas > Period > Single Back to Back**.

This measurement takes consecutive period measurements without dead time by using time-stamping.

Every positive or negative zero crossing (depending on the selected slope) up to the maximum frequency (125 kHz with interpolator calibration **On** or 250 kHz with interpolator calibration **Off**) is time-stamped. For every new time stamp the previous value is subtracted from the current value and displayed.

In **Value** mode the display is updated every new period if the period time exceeds 200 ms. For shorter times, every second, third, fourth, and so on result is displayed due to the limited updating rate.

In **Analyze** mode the graphs and statistical data contain all periods up to the maximum input frequency. For higher frequencies the instrument displays the average period time during the 4 μ s or 8 μ s observation. So, for higher frequencies the actual function is Period Average Back-to-Back.

The main purpose of this function is to make continuous measurements of relatively long period times without losing single periods due to result processing. A typical example is the 1 pps time base output from GPS receivers.

Average A, B Menu path: **Meas > Period > Average**.

The instrument measures the average period of the signal. This measurement provides a higher resolution readout than the Single Period measurement.

Frequency

**Freq A, B Back-to-Back
(FCA3100 Series Only)**

Menu path: **Meas > Freq > Single Back to Back**.

This measurement uses time stamping to take consecutive frequency measurements without dead time.

This is the inverse function of Period Back-to-Back. In Analyze mode, measurement time is used for pacing the time stamps. The pacing parameter is not used in this case.

Consecutive frequency average measurements without dead time are used to calculate Allan deviation. Such statistical measures are widely used by oscillator manufacturers to describe short-term stability.

Time Measurements

Introduction

Measuring the time between a start and a stop condition on two separate channels is the basis for all time interval measurements. In addition to **Time Interval A to B**, the counters also offer other channel combinations and derived functions like **Pulse Width** and **Rise/Fall Time**.

Time is measured between the trigger point and the reset point. Accurate measurements are possible only if the hysteresis band is narrow.

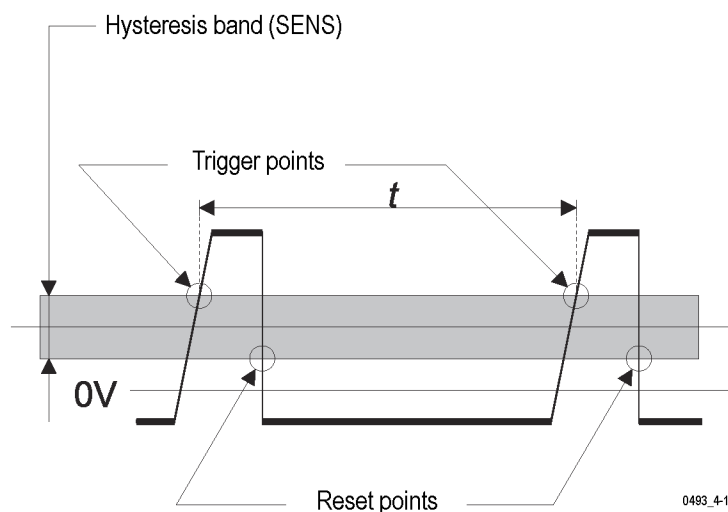

Triggering and Time Measurements

The set trigger level and trigger slope define the start and stop triggering. If **Auto** is on, the instrument sets the trigger level to 50% of the signal amplitude, which is ideal for most time measurements.

Summary of conditions for reliable time measurements.

- **Auto Once**, or setting the trigger levels determined by **Auto Trig**, is normally the best choice when making time measurements. Push **Man Trig** and push **Auto Set** once.
- **DC** coupling.
- **1x** Attenuation. Selected automatically if **Auto Set** was used before to set the trigger levels.
- High signal level.
- Steep signal edges.

Even though the input amplifiers have high sensitivity, the hysteresis band has a finite value that would introduce a small timing error for signals with different rise and fall times, for instance asymmetrical pulse signals like those in the previous figure. This timing error is taken care of by using hysteresis compensation that virtually moves the trigger points by half the hysteresis band.

Time Interval

Menu path: **Meas > Time > Time Interval**.

The Time Interval measurements let you measure rise and fall times between specified trigger levels.

Use the **Input A/B > Slope** button (marked with a positive slope edge or negative slope edge symbol) to set the signal edge on which to start or stop the measurement.

- Time Interval A to B: The instrument measures the time between a start condition on Input A and a stop condition on Input B.
- Time Interval B to A: The instrument measures the time between a start condition on Input B and a stop condition on Input A.
- Time Interval A to A, B to B: When the same (common) signal source supplies both start and stop trigger events, connect the signal to either Input A or Input B.

Rise/Fall Time A/B

Menu path: **Meas > Time > Rise Time**, **Meas > Time > Fall Time**.

By convention, rise/fall time measurements are taken from when the signal passes 10% of its amplitude to when it passes 90% of its amplitude.

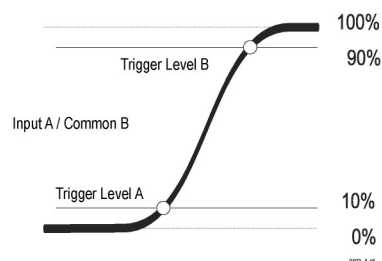

The instrument calculates and sets the trigger levels. Rise and fall time can be measured on both Input A and Input B.

Other parameters also measured are Slew Rate (V/s), V_{\max} and V_{\min} .

For ECL circuits, the reference levels are 20% (start) and 80% (stop). In this case you can use either of two methods to set the reference values:

1. Select the general *Time Interval* function described above and set the trigger levels manually after calculating them from the absolute peak values. Then you can benefit from the auxiliary parameters V_{\max} and V_{\min} . For measurements made on Input A, use the following settings:

Rise Time:

$$\text{Trig Level A} = V_{\min} + 0.2 (V_{\max} - V_{\min})$$

$$\text{Trig Level B} = V_{\min} + 0.8 (V_{\max} - V_{\min})$$

Fall Time:

$$\text{Trig Level A} = V_{\min} + 0.8 (V_{\max} - V_{\min})$$

$$\text{Trig Level B} = V_{\min} + 0.2 (V_{\max} - V_{\min})$$

2. Select one of the dedicated Rise/Fall Time measurements and manually adjust the relative trigger levels (in %) when Auto Trigger is active. Use both input channel menus to enter the trigger levels, even though only one channel is the active signal input.

Overshoot or ringing can also affect your measurement. (See page 53, *Auto Trigger*.)

Time Interval Error (TIE) (FCA3100 Series Only)

Menu path: **Meas > Time > TIE**.

TIE measurement uses continuous time-stamping to observe slow phase shifts (wander) in nominally stable signals during extended periods of time. Monitoring distributed PLL clocks in synchronous data transmission systems is a typical application.

TIE measurements are only applicable to clock signals, not data signals.

The frequency of the signal to be checked can be either manually or automatically set. **Auto** detects the frequency from the first two samples. The value is rounded to four digits, for example 2.048 MHz and is output on the bus when a query is sent. It is also displayed as an auxiliary measurement in **Value** mode.

TIE is measured as the time interval between the input signal and the internal or external timebase clock. These signals are not phase-locked, so irrespective of the real time interval value at the start of a measurement, the result at $t = 0$ is mathematically nulled. The graphic representation in **Analyze** mode starts at the coordinate origin.

Pulse Width A/B

Menu path: **Meas > Pulse > Width Positive, Meas > Pulse > Width Negative.**

Either Input A or Input B can be used for measuring, and both positive and negative pulse width can be selected.

- Positive pulse width means the time between a rising edge and the next falling edge.
- Negative pulse width means the time between a falling edge and the next rising edge.

The selected trigger slope is the start trigger slope. The instrument automatically selects the inverse polarity as the stop slope.

Duty Factor A/B

Menu path: **Meas > Pulse > Duty Factor Positive, Meas > Pulse > Duty Factor Negative.**

Duty factor (or duty cycle) is the ratio between pulse width and period time:

$$Duty\ factor = \frac{Pulse\ width}{Period}$$

The instrument determines this ratio in one pass by taking three time stamp measurements (two consecutive positive trig-A and one negative trig-A, if the selected measurement function is Duty Factor Positive on Input A).

You can use either Input A or Input B for taking measurements, for both positive and negative duty factors. The instrument also displays Period and Pulse Width measurements.

NOTE. *The total measurement time is tripled compared to a single measurement because the measurement requires three measurement steps.*

Time Measurement Errors

Hysteresis The trigger hysteresis can cause time measuring errors. Timing measurement triggers occur when the input signal crosses the entire hysteresis band, not when the input signal crosses at 50 percent of the amplitude, as shown in the following figure:

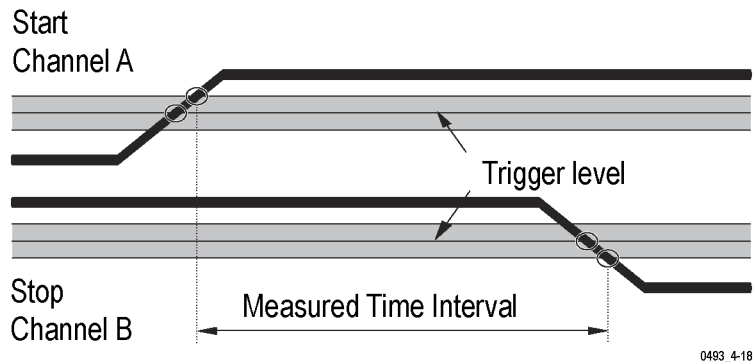

0493_4-18

The hysteresis band is about 20 mV at 1x attenuation, and 200 mV at 10x attenuation.

To keep hysteresis trigger error low, set the attenuator to **1x** when possible. Use 10x attenuation only when input signals have excessively large amplitudes, or when you need to set trigger levels higher than 5 V.

Overdrive and Pulse Rounding

Additional timing errors can be caused by triggering with insufficient signal overdrive. When triggering occurs too close to the maximum voltage of a pulse, two phenomena may influence your measurement uncertainty: overdrive and rounding.

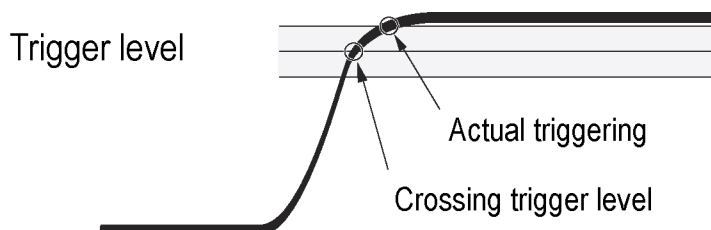

0493_4-17

Overdrive. When the input signal crosses the hysteresis band with only a marginal overdrive, triggering may take some 100 ps longer than usual. The specified worst case 500 ps systematic trigger error includes this error. To avoid this error, make sure that the input signal or trigger level has adequate overdrive.

Pulse rounding. Very fast pulses may suffer from pulse rounding, overshoot, or other aberrations. Pulse rounding can cause significant trigger errors, particularly when measuring on fast circuitry.

Auto Trigger Auto trigger is very effective for measuring unknown signals. However, overshoot and ringing can cause Auto trigger to choose slightly wrong minimum and maximum signal levels. This does not affect measurements like frequency, but transition time measurements may be affected. Therefore, when working with known signals such as logic circuitry, set the trigger levels manually.

Always use manual trigger levels if the signal repetition rate drops below 100 Hz (default), or below the low frequency limit set by entering a value between 1 Hz and 50 kHz in the Auto trigger low frequency menu **Settings > Misc > Auto Trig Low Freq**.

Phase Measurements

Phase is the time difference between two signals of the same frequency, expressed as an angle.

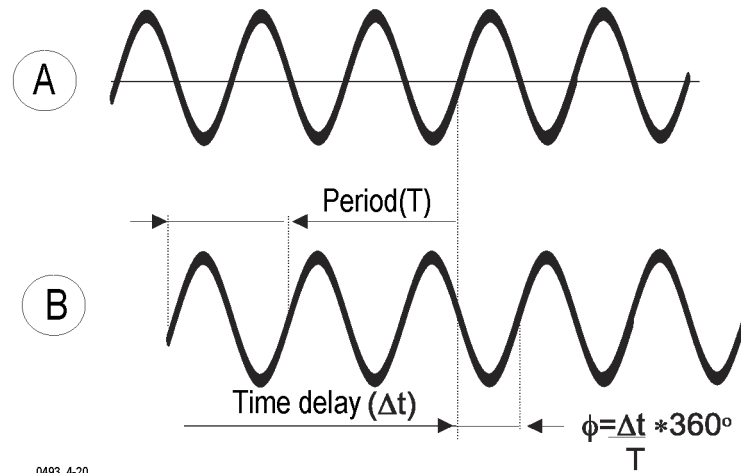

0493_4-20

The traditional method to measure phase delay with a timer/instrument is a two-step process consisting of two consecutive measurements; a period measurement followed immediately by a time interval measurement. The phase delay is then mathematically calculated as:

$$\frac{360^\circ \times (\text{Time Interval } A-B)}{\text{Period}}$$

or in other words:

$$\text{Phase } A-B = 360^\circ \times \text{Time Delay} \times \text{Freq}$$

The FCA3000, FCA3100, and MCA3000 Series instruments use a more elaborate method to determine phase. Both measurements are taken in one pass along with the measurement time stamp. Two consecutive time-stamps from trigger events on Input A and Input B are enough to calculate the phase difference, including the phase relationship of the signals.

Resolution

You can take phase measurements on signals up to 160 MHz. The measurement resolution depends on the frequency. For frequencies below 100 kHz the resolution is 0.001°; for frequencies above 10 MHz it is 1°. Phase measurement resolution can be further improved by using the built-in statistics functions to average the measurement.

Possible Errors

Phase can be measured on input signal frequencies up to 160 MHz. However, at these very high frequencies the phase resolution is reduced to:

$$100 \text{ ps} \times 360^\circ \times \text{FREQ}$$

Inaccuracies

The inaccuracy of Phase A-B measurements depends on several external parameters:

- Input signal frequency
- Peak amplitude and slew rate for input signals A and B
- Input signal S/N-ratio

Some internal instrument parameters are also important:

- Internal time delay between Input A and B signal paths
- Variations in the hysteresis window between Input A and B

There are two types of phase measurement inaccuracy errors: random errors and systematic errors. The random errors consist of resolution (quantization) and noise trigger error. Systematic errors consist of “inter-channel delay difference” and “trigger level timing” errors. Systematic errors are constant for a given set of input signals, and in general, you can compensate for them in the controller (GPIB-systems) or locally using the **Math/Limit** menu (manual operation) after making calibration measurements. (See page 58, *Methods of compensation*.)

Random errors in phase measurements. The phase quantization error algorithm is:

$$100 \text{ ps} \times 360^\circ \times \text{FREQ}$$

For example, the quantization error for a 1 MHz input signal is:

$$100 \text{ ps} \times 360^\circ \times (1 \times 10^6) \approx 0.04^\circ$$

The trigger noise error consists of *start* and *stop* trigger errors that should be added. For sinusoidal input signals each error is:

$$\frac{360^\circ}{2\pi \times s/n \text{ ratio}}$$

Use the example above and add some noise so that the S/N ratio is 40 dB. This corresponds to an amplitude ratio of 100 times (and power ratio of 10000 times). Then the trigger noise will contribute to the random error with:

$$\frac{360^\circ}{2\pi \times 100} \approx 0.6^\circ$$

The sum of random errors should not be added linearly, but in an “RMS way”, because of their random nature. Do this for the examples above:

Random error

$$\text{Random error} = \sqrt{\text{quant. err.}^2 + \text{start trg.err}^2 + \text{stop trg.err}^2}$$

The total random errors are thus:

$$\sqrt{0.04^2 + 0.6^2 + 0.6^2} \approx 0.85^\circ \text{ (single shot)}$$

What about random errors caused by internal amplifier noise? Internal noise contribution is normally negligible. The phase error caused by noise on the signal, whether internal or external, is:

$$\frac{360^\circ}{2\pi \times s/n \text{ ratio}}$$

For an input signal of 250 mV_{rms} and the typical internal noise figure of 250 μV_{rms} gives us a S/N-ratio of at least 60 dB (1000 times). This gives us a worst case error of 0.06°. Increasing the input signal to 1.5 V_{rms} decreases the error to 0.01°.

Another way to decrease random errors is to use the statistics features of the instrument and calculate the mean value from several samples.

Systematic errors in phase measurements. Systematic errors consist of the following elements:

- Inter-channel propagation delay difference.
- Trigger level timing errors (start and stop), due to trigger level uncertainty.

The inter-channel propagation delay difference is typically 500 ps at identical trigger conditions in both input channels. Therefore, the corresponding phase difference is:

$$<0.5 \text{ ns} \times 360^\circ \times \text{FREQ}$$

The following table lists the phase differences caused by inter-channel propagation delay differences, by frequency:

Frequency	Phase error in degrees
160 MHz	28.8°
100 MHz	18.0°
10 MHz	1.8°
1 MHz	0.18°
100 kHz	0.018°
10 kHz and below	0.002°

The trigger level timing error depends on the following factors:

- The actual trigger point is not exactly zero, due to trigger level DAC uncertainty and comparator offset error.
- The two signals have different slew rates at the zero-crossing.

Every instrument has input hysteresis. This is necessary to prevent noise from causing erroneous input triggering. The width of the hysteresis band determines the maximum sensitivity of the instrument. It is approximately 30 mV, so when you set a trigger level of 0 V, the actual trigger point would normally be +15 mV and the recovery point -15 mV. This kind of timing error is canceled out by using hysteresis compensation.

Hysteresis compensation means that the microcomputer can offset the trigger level so that actual triggering (after offset) equals the set trigger level (before offset). This general hysteresis compensation is active in phase, time interval, and rise/fall time measurements. There is a certain residual uncertainty of a few mV and there is also a certain temperature drift of the trigger point.

The nominal trigger point is 0 V with an uncertainty of ± 10 mV.

A sine wave expressed as:

$$V(t) = V_p \times \sin(2\pi ft)$$

has a slew rate $\frac{\Delta V}{\Delta t}$ of $V_p \times 2\pi f$ close to the zero-crossing. This provides the systematic time error when crossing 10 mV, instead of crossing 0 mV.

$$\frac{10 \text{ mV}}{(V_p \times 2\pi \times \text{FREQ})}$$

The corresponding phase error in degrees is listed in the following table:

Frequency	Phase error in degrees
160 MHz	28.8°
100 MHz	18.0°
10 MHz	1.8°
1 MHz	0.18°
100 kHz	0.018°
10 kHz and below	0.002°

$$\frac{10 \text{ mV} \times 360^\circ \times \text{FREQ}}{V_p \times 2\pi \times \text{FREQ}}$$

which can be reduced to:

$$\frac{0.6}{V_p} \text{ (in } ^\circ \text{)}$$

This error can occur on both inputs, so the worst case systematic error is thus:

$$\frac{0.6}{V_p(A)} + \frac{0.6}{V_p(B)} \text{ (in } ^\circ \text{)}$$

Methods of compensation. The calculations above show the typical uncertainties in the constituents that make up the total systematic phase error. For a given set of input signals you can compensate for this error more or less completely by making calibration measurements. Depending on the acceptable residual error, you can use one of the methods described below. The first one is very simple but does not take the inter-channel propagation delay difference into account. The second one includes all systematic errors, if it is carried out meticulously, but it is often not practicable.

Calibration measurement method 1.

1. Connect the test signals to Input A and Input B.
2. Select the function **Phase A rel A** to find the initial error.
3. Use the **Math/Limit** menu to enter this value as the constant **L** in the formula $K \cdot X + L$ by pressing X_0 and change the sign.
4. The current measurement result (X_0) is subtracted from the future phase measurements made by selecting **Phase A rel B**. A considerable part of the systematic phase errors will thus be canceled out. Note that this calibration has to be repeated if the frequency or the amplitude changes.

Calibration measurement method 2.

1. Connect one of the signals to be measured to both Input A and Input B using a 50 Ω power splitter or a BNC T-piece, depending on the source impedance. Make sure the cable lengths between power splitter / T-piece and instrument inputs are equal.
2. Select the function **Phase A rel B** and read the result.
3. Enter this value as a correction factor in the same way as described above for Method 1.
4. To minimize the errors, keep the input signal amplitude constant to minimize the deviation between calibration and measurement.
5. The same restrictions as for Method 1 regarding frequency and amplitude apply to this method; you should recalibrate whenever one of the signal frequency or amplitude changes.

Common settings for the signal inputs are:

Slope	Pos or Neg
Coupling	AC
Impedance	1 M Ω or 50 Ω depending on source and frequency
Trigger	Manual
Trigger Level	0 V
Filter	Off

Residual systematic error. By mathematically (on the bench or in the controller) applying corrections according to one of the methods mentioned above, the systematic error is reduced, but not fully eliminated. The residual time delay error will most probably be negligible, but a trigger level error will always remain to a certain extent, especially if the temperature conditions are not constant.

Totalize (FCA3100 Series Only)

Menu path: **Meas > Totalize.**

The **Totalize** functions add up the number of trigger events on the two instrument inputs A and B. Five totalize functions are available.

In addition to controlling the gate manually by toggling **Hold/Run** (manual totalize function), you can also open and close the gate by using the arming facilities under **Settings**. The different functions are described below.

The display is updated continually while the gate is open. Events are accumulated during consecutive open periods until you do a **Restart**.

NOTE. *The manual Totalize functions cannot be used in conjunction with the Statistics functions or parameters like block and pacing.*

Auto trigger does not work in the normal way for Totalize. An Auto Once action is performed before the start of a totalize measurement to calculate and set suitable trigger levels once.

- | | |
|---------------------|--|
| Totalize A | This measurement lets you totalize (count) the number of trigger events on Input A. Auxiliary calculated parameters are A-B and A/B . Start/Stop is manually controlled by toggling the button Hold/Run , and the counting registers are reset by pressing Restart . |
| Totalize B | This measurement lets you totalize (count) the number of trigger events on Input B. Auxiliary calculated parameters are A-B and A/B . Start/Stop is manually controlled by toggling the button Hold/Run , and the counting registers are reset by pressing Restart . |
| Totalize A+B | This measurement lets you calculate the sum of trigger events on Input A and Input B. Auxiliary parameters are A and B . Start/Stop is manually controlled by toggling the button Hold/Run , and the counting registers are reset by pressing Restart . |

Totalize A–B This measurement lets you calculate the difference between trigger events on Input A and Input B. Auxiliary parameters are **A** and **B**. Start/Stop is manually controlled by toggling the button **Hold/Run**, and the counting registers are reset by pressing **Restart**.

The **TOT A–B MAN** makes it possible, for instance, to make differential flow measurements in control systems.

Example: The number of cars in a parking lot equals the number of cars passing the entrance (A) gate, minus the ones passing the exit (B) gate.

Totalize A/B This measurement lets you calculate the ratio of trigger events on Input A and Input B. Auxiliary parameters are **A** and **B**. Start/Stop is manually controlled by toggling the button **Hold/Run**, and the counting registers are reset by pressing **Restart**.

Totalize and Arming By using **Arming** together with **Totalize** you can open and close the gate with an external signal applied to one of the channels **A**, **B**, or **E**. In this way you can access functions like **TOT A Start/Stop by B**, **TOT A-B Gated by E**, and **TOT B Timed by A**, by selecting channel, slope and delay time for Start/Stop.

Unlike the manual **Totalize** functions, the armed totalize functions allow block and pacing control. So all the *Statistics* functions are available. A new result is displayed after each stop condition.

NOTE. *If you set Start arming, you must also set a Stop arming condition on Input A, Input B, Input E, or Time.*

Examples. The Arming parameters are in the menu **Settings > Arm**.

To set up the **Totalize** functions above, do the following:

Totalize A, Start/Stop by B.

1. Select **Totalize** from the **Meas** menu and then **A**.
2. Connect the signal to be measured to Input A.
3. Set the trigger level for Input A manually to a suitable value.
4. Connect the control signal to Input B.
5. Set the trigger level for Input B manually to a suitable value.
6. Push **Settings > Arm** and set the following parameters:
 - *Arm on Sample/Block:* Decide if each event or each block of events (Analysis mode) should be armed.
 - *Start Channel:* Select B.

- *Start Slope*: Select Positive slope (marked by a rising edge symbol).
- *Start Delay*: Decide if you need to insert a delay (10 ns - 2 s) between the control signal and the actual opening of the gate.
- *Stop Delay*: Decide if you need to insert a delay (10 ns - 2 s) during which the gate will not respond to the control signal on the Stop Channel. The main application is to prevent relay contact bounces from closing the gate prematurely.
- *Stop Channel*: Select B.
- *Stop Slope*: Select Positive slope (marked by a rising edge symbol).

Totalize A-B gated by E.

1. Push **Meas > Totalize > A-B**.
2. Connect the signals to be measured to Inputs A and B.
3. Set the trigger levels for Inputs A and B manually to suitable values.
4. Connect the control signal (TTL levels) to Input E.
5. Push **Settings > Arm** and set the following parameters:
 - *Arm on Sample/Block*: Decide if each event or each block of events (STATISTICS mode) should be armed.
 - *Start Channel*: Select **E**.
 - *Start Slope*: Select Positive slope (marked by a rising edge symbol).
 - *Start Delay*: Decide if you need to insert a delay (10 ns - 2 s) between the control signal and the actual opening of the gate.
 - *Stop Delay*: Decide if you need to insert a delay (10 ns - 2 s) during which the gate will not respond to the control signal on the Stop Channel. The main application is to prevent relay contact bounces from closing the gate prematurely.
 - *Stop Channel*: Select **E**.
 - *Stop Slope*: Select Negative slope (marked by a falling edge symbol).

Totalize B timed by A. With this function you can synchronize the start of an accurate gate time to an external event.

1. Push **Meas > Totalize > B**.
2. Connect the signal to be measured to Input B.
3. Set the trigger level for Input B manually to a suitable value.
4. Connect the control signal to Input A.

5. Set the trigger level for Input A manually to a suitable value.
6. Push **Settings** > **Arm** and set the following parameters:
 - *Arm on Sample/Block*: Decide if each event or each block of events (STATISTICS mode) should be armed.
 - *Start Channel*: Select **A**.
 - *Start Slope*: Select Positive slope (marked by a rising edge symbol).
 - *Start Delay*: Decide if you need to insert a delay (10 ns - 2 s) between the control signal and the actual opening of the gate.
 - *Stop Delay*: Set the measurement time between 10 ns and 2 s.
 - *Stop Channel*: Select **Time**.

Voltage Measurements

V_{MAX} , V_{MIN} , and V_{PP}

The instrument can measure the input voltage levels V_{MAX} , V_{MIN} and V_{PP} on DC input voltages (from -50 V to $+50$ V in two automatically selected ranges) and on repetitive signals between 1 Hz and 300 MHz. Measurement accuracy is about 1% of the reading.

Push **Meas** > **Volt** to open the voltage measurement menu.

The default low frequency limit is 20 Hz but can be changed using the **Settings** > **Misc** (miscellaneous) menu to change the limit to between 1 Hz and 50 kHz. A higher low-frequency limit means faster measurements.

Selecting a voltage measurement displays that measurement in large digits and with full resolution. The other measurements are displayed along the bottom of the display in smaller characters.

Voltage measurements are determined by taking a series of trigger level settings and sensing when the instrument triggers.

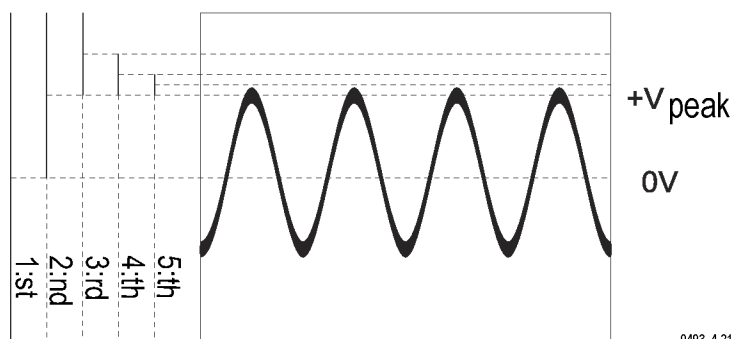

V_{RMS}

When the waveform (sinusoidal, triangular, square) of the input signal is known, its crest factor, defined as the quotient (Q_{CF}) of the peak (V_p) and RMS (V_{rms}) values, can be used to set the constant K in the mathematical function $K * X + L$. The display shows the actual V_{rms} value of the input signal, assuming that V_{pp} is the main parameter.

$$V_{rms} = \frac{1}{2Q_{cf}} V_{pp}$$

For example, a sine wave has a crest factor of 1.414 ($\sqrt{2}$), so the constant in the formula above will be 0.354. To set this:

1. Push **Math/Limit > Math > Math(Off) > K*X+L**.
2. Push **K** and enter **0.354**.
3. Check that the **L** constant is set to its default setting of **0** (zero).
4. Confirm your choices with the menu softkeys below the display and exit the menus.

If the input is AC coupled and V_{pp} selected, the display shows the RMS value of any sine wave input.

If the sine wave is superimposed on a DC voltage, the RMS value is found as:

$$0.354 * V_{pp} + V_{DC}$$

If V_{DC} is not known it can be found as:

$$V_{rms} = \frac{V_{MAX} - V_{MIN}}{2}$$

To display the rms value of a sine wave superimposed on a DC voltage, follow the example above, but set $L = V_{DC}$.

Math and Statistical Measurements

The instruments provide Averaging, Mathematics and Statistics post-processing functions. You can use these functions separately or combine them.

Averaging

The **Frequency** and **Period Average** measurements use hardware-based averaging (counting clock pulses during several full input signal cycles) for their averaged measurement results. All other measurements use a software-based mean average method to calculate the measurement average. Use the statistical Numerical mode to display averaged results for measurements other than Frequency and Period Average.

Use **Settings > Meas Time** to set the measurement time (range is 20 ns to 1000 s, 20 ns resolution, and 200 ms default value). Increasing the measurement time displays more digits (higher resolution) but fewer measurements per second. Meas Time is only applicable to **Frequency** and **Period Average** measurements.

The default Meas Time setting displays 11 digits and provides four to five measurements per second.

NOTE. To quickly select the lowest measurement time (20 ns), enter 0. The instrument will select 20 ns automatically.

Mathematics

The instrument has five predefined mathematical expressions with which to process the measurement result before displaying the values on the screen. The available math expressions are:

- $K * X + L$
- $K / X + L$
- $(K * X + L) / M$
- $(K / X + L) / M$
- $X / M - 1$

These expressions are in the **Math/Limit > Math** submenu.

X is a placeholder for the measurement result. The default values of K, L, and M are chosen so that the measurement result is not affected directly after activating **Math**. Recalling the default factory setting restores these values as well.

For example, to measure the deviation from a certain initial frequency (instead of measuring the frequency itself), do the following:

1. Recall the default settings by pressing **User Opt > Save/Recall > Recall Setup > Default**.
2. Connect the signal to be measured to **Input A**.
3. Push **Auto Set** to let the instrument find the optimum trigger conditions on its own.
4. Push **Math/Limit > Math > L**.
5. You can set the value of L in one of two ways:
 - If the current measurement value is suitable for your purpose, then push **X₀** to transfer the value to the constant L. You can repeat pushing **X₀** until you have set the value you want.
 - Manually enter a numerical value by using the keypad.
6. Push **Save|Exit** to confirm and save the value.
7. Push **Math** and select the expression **K*X+L**. The display shows the deviation from the value that you entered.

Use the **K** constant to scale a measurement result.

Use the expression **X/M-1** if you want the result to be a relative deviation.

Statistics

Statistics can be applied to all measurements and can also be applied to the result from Mathematics processing. You access statistical readouts by pushing the Analyze button to toggle.

The available statistics readouts are:

- Max: Displays the maximum value within a sampled population of N x_i values.
- Min: Displays the minimum value within a sampled population of N x_i values.
- P-P: Displays the peak-to-peak deviation within a sampled population of N x_i values.
- MEAN (as part of the main measurement readout): Displays the arithmetic mean value (\bar{x}) of a sampled population of N x_i values and is calculated as:

$$\bar{X} = \frac{1}{N} \sum_{i=1}^N X_i$$

- Std: Displays the standard deviation (s) of a sampled population of N values and is calculated as follows. It is defined as the square root of the variance.

$$S = \sqrt{\frac{\sum_{i=1}^N (X_i - \bar{X})^2}{N-1}}$$

- **Adev:** Displays the Allan deviation (σ) of a sampled population of N values and is calculated as follows. It is defined as the square root of the Allan variance.

$$\sigma = \sqrt{\frac{\sum_{i=1}^{N-1} (X_{i+1} - X_i)^2}{2(N-1)}}$$

The number N in the statistic expressions is the number of samples, and is an integer value between 2 and 2×10^9 .

Allan Deviation Versus Standard Deviation

Allan deviation is a statistic used for characterizing short-term instability (such as typically caused by jitter and flutter) by taking samples (measurements) at short intervals. The idea is to eliminate the influence of long-term drift due to aging, temperature, or wander by making consecutive comparisons of adjacent samples.

Standard deviation, which is probably a more familiar statistic, considers the effects of all types of deviation, as all samples in the population are compared with the total mean value.

Both Allan and Standard deviations are expressed in the same units as the main measurement, such as Hertz or seconds.

Setting Sampling Parameters

1. Push **Settings > Stat**.
2. Push **No. of samples** and enter a value by using the numerical buttons or the **Up/Down** arrow buttons. Push **Save/Exit** to save the value.
3. For histogram displays, push **No. of Bins** and enter a value. Push **Save/Exit** to save the value.
4. Push **Pacing time** and enter a value (range is 2 μ s - 500 s, default value 20 ms). The pacing parameter sets the sampling interval.
5. Activate the set pacing time by pushing **Pacing Off** to change it to **Pacing On**. Status *Pacing Off* means that the specified number of samples is taken with minimum delay.
6. Push **Hold/Run** to stop the measuring process.

7. Push **Restart** to initiate one data capture.
8. Toggle **Analyze** to view the measurement result in each of the different statistical presentation modes.

NOTE. *The instrument updates the screen with intermediate results until the complete data capture is done.*

Statistics and Measurement Speed

When using statistics, you must take care that a measurement does not take too long a time to perform. A measurement based on 1000 samples does not give a complete statistical result until all 1000 measurements are taken. It can take a long time to display a statistical measurement if the instrument setting is not optimal.

Here are a few tips to speed up the statistical measurement process:

- Do not use Auto trigger. In Auto trigger mode, the instrument calculates the trigger levels before each measurement. Determine a good trigger level and set it manually.
- Do not use a longer measuring time than is necessary for the required resolution.
- Remember to use a short pacing time (measurement interval) if your application does not require data collection over a long period of time.

NOTE. *The instrument displays intermediate results during the measurement process.*

Determining Long or Short Time Instability

When making statistical measurements, you must select measuring time in accordance with your measurement goal. For example, jitter or very short time (cycle to cycle) variations require that the samples be taken as single measurements.

If average is used (Freq or Period Average only), the samples used for the statistical calculations are already averaged, unless the set measuring time is less than the period time of the input signal (up to 160 MHz). Above this frequency prescaling by two is introduced, and as a result a certain amount of averaging. This can be a great advantage when you measure medium or long time instabilities. Here averaging works as a smoothing function, eliminating the effect of jitter.

The signal in the following figure contains a slow signal variation as well as jitter. When measuring jitter you should use a limited number of samples so that the slow variation does not significantly affect the measurement. You can alternatively use the Allan deviation statistic measure for this kind of measurement.

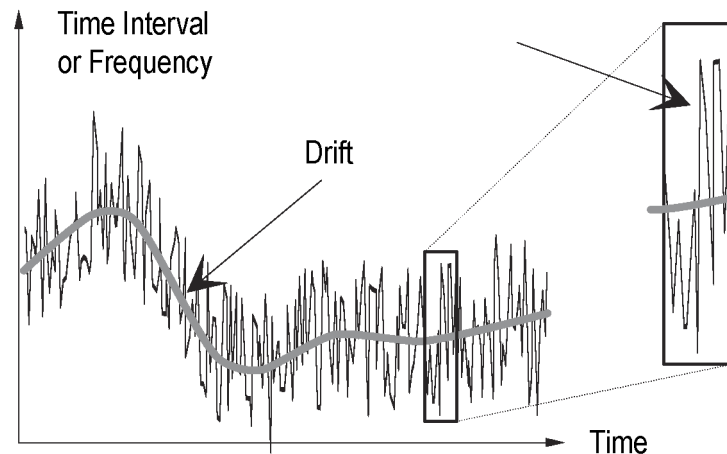

0493_6-1

To measure the slower variation, calculate the Max, Min, or Mean values on a long series of averaged samples. Averaging eliminates the jitter in each sample and the long measuring time and large number of samples means that the measurement can record very slow variations. The maximum pacing time is 500 s, the maximum measuring time for each sample is 1000 s, and the maximum number of samples is $2 \cdot 10^9$.

Statistics and Mathematics

The instrument allows you to perform mathematical operations on the measured value before it is presented to the screen or to the bus. Any systematic measurement uncertainty can be measured for a particular measurement setup, and the needed correction constants can be entered into the appropriate math operation. Statistics are then applied to the corrected measured value.

Confidence Limits

You can use standard deviation results to calculate the confidence limits of a measurement.

$$\text{Confidence limits} = \pm k s_x$$

Where:

s_x = standard deviation

$k = 1$ for a confidence level of 68.3% (1σ – limits)

$k = 2$ for a confidence level of 95.5% (2σ – limits)

$k = 3$ for a confidence level of 99.7% (3σ – limits)

Example of calculating confidence limits. The following example calculates the confidence limits of a 100 μs time interval measurement. Use the Numerical statistics mode to read the mean value and standard deviation of the time interval. Take sufficient samples to get a stable reading. Assume that the start and stop trigger transitions are fast and do not contribute to the measurement uncertainties.

The instrument displays a Mean value = 100.020 μ s and a Std Dev = 50 ns.

Therefore the 95.5% confidence limits = $\pm 2s_x$ ($= \pm 2 * 50$ ns) = ± 100 ns.

The 3σ limit will then be $\pm 3 * 50$ ns = ± 150 ns

Jitter Measurements

Statistics provides an easy method to determine the short-term timing instability (jitter) of pulse signals. The jitter is usually specified with its rms value, which is equal to the standard deviation based on single measurements. The instrument can directly measure and display the rms jitter.

Otherwise, the standard deviation of mean values can be measured. The rms value is a good measure to quantify the jitter, but it gives no information about the distribution of the measurement values.

To improve a design, it might be necessary to analyze the distribution. Use the instrument statistical analysis functions to take trend analysis measurements. Push the **Analyze** button to step through the numeric and graphic statistical presentation modes.

You can gain greater analysis versatility by using a remote controller (GPIB or USB) and the optional TimeView™ Modulation Domain Analysis Software application.

Limit Testing

The Limits Mode makes the instrument an efficient alarm condition monitor (limit tester). You can monitor measurement results in real time and set an action to take when a limit condition is exceeded. Push **Math/Limit > Limits** to open the Limits menu.

Use the Lower Limit and Upper Limit menu items to set the limit testing levels.

Limit Behavior Push **Limit Behavior** to set how the instrument will respond on limit crossings. The available limit response behaviors are:

- **Off**: Take no action. The **LIM** indicator is not displayed.
- **Capture**: Capture the measurement that exceeds a limit setting and flash the **LIM** indicator. Continue taking measurements. Only samples meeting the test criterion are part of the population in statistics presentations.
- **Alarm**: Flash the **LIM** indicator and continue taking measurements. All samples, including those outside the limits, are part of the population in statistics presentations.
- **Alarm_stop**: Flash the **LIM** indicator and stop taking measurements (put instrument in Hold). The instrument displays the measurement that caused the limit detector to trigger. Only samples taken before the alarm condition are part of the population in statistics presentations.

The alarm conditions can also be detected using the SRQ function on the GPIB bus. See the *FCA3000, FCA3100, and MCA3000 Series Programmer Manual*.

Limit Test Modes There are three limit testing modes:

- **Above**: Measurements above the set lower limit will pass. A flashing **LIM** symbol on the screen means that the measurement result was below the lower limit at least once since the measurement started. Use **Restart** to reset the **LIM** symbol to its non-flashing state.
- **Below**: Measurements below the set upper limit will pass. A flashing **LIM** symbol on the screen means that the measurement result was above the upper limit at least once since the measurement started. Use **Restart** to reset the **LIM** symbol to its non-flashing state.
- **Range**: Measurements between (within) the specified limits will pass. A flashing **LIM** symbol on the screen means that the measurement result was below the lower limit or above the upper limit at least once since the measurement started. Use **Restart** to reset the **LIM** symbol to its non-flashing state.

If **Range** is selected and the presentation mode is **Value**, a simple graphic representation of the current measurement value in relation to the limits can be seen at the same time as the numerical value.

The upper limit (UL) and the lower limit (LL) are vertical bars below the main numerical display, and their numerical values are displayed in small digits adjacent to the bars.

This type of graphic resembles a classic analog pointer instrument, where a happy face emoticon means that measurements are within the set limits. An unhappy face emoticon means that measurements are outside the set limits but are still within the display area. Measurements that fall outside the display area are represented by a < at the left edge or a > at the right edge of the screen.

The location of the limit indicator bars is fixed such that the limit range takes up the mid third of the screen area. This means that the resolution and the scale length are set by the specified limits.

Limits and Analyze Mode

You can apply limit testing to trend plots and histograms (Analyze modes). Using limits in trend plots and histograms inhibits auto-scaling and indirectly sets the scale length and resolution of the plots.

Arming

Arming starts and/or stops measurement acquisition when the instrument detects a change on a specified input signal. The available arming types are Arm Start and Arm Stop (in the **Settings** > **Arm** menu).

Arming is useful for taking frequency measurements in more complex signals such as:

- Single-shot events or non-cyclic signals
- Pulse signals where pulse width or pulse positions can vary
- Signals with frequency variations versus time (profiling)
- A selected part of a complex waveform signal

Arming occurs when the instrument detects the appropriate signal slope on the arming input (Input A, Input B, or Input E). You can also set a delay period from the start arm detection to when to actually take the measurement, and a stop arm condition (slope and delay time) to extend the measurement period.

Guidelines

- You can use Arm Start with all measurements except **Frequency Burst**, **Ratio**, and **Volt**. If you use start arming with an average measurement, it only controls the start of the first sample.
- You can use Arm Stop with all measurements except **Frequency Burst**, **Ratio**, **Volt**, and **Rise/Fall Time**.
- Arming disables the normal free-run mode; no measurement is taken until the instrument detects a valid start arming signal condition.
- You can use Input A, Input B, and Input E (on rear panel) for the start or stop arm source. The frequency range for Input A and Input B is 160 MHz. The frequency range for Input E is 80 MHz (TTL levels).
- Arming measurements that use Input A or B as the arming signal are limited to 160 MHz signals, unless the arming condition within the signal occurs at a frequency lower than 160 MHz.

Start and Stop Arming

Arm Start Arm Start acts like an external trigger on an oscilloscope. It synchronizes the start of the actual measurement to a signal event. You can also use delay with the Arm Start function to delay the start of a measurement with respect to the arming pulse. Arm Start can be used alone to take a measurement, or combined with Arm Stop to take longer measurements.

The available Arm Start parameters are Channel, Slope, and Delay.

Signal sources that generate complex waveforms like pulsed RF, pulse bursts, TV line signals, or sweep signals, often generate a *sync* signal that coincides with the start of a sweep, length of an RF burst, or the start of a TV line. You can use this sync signal to arm the instrument.

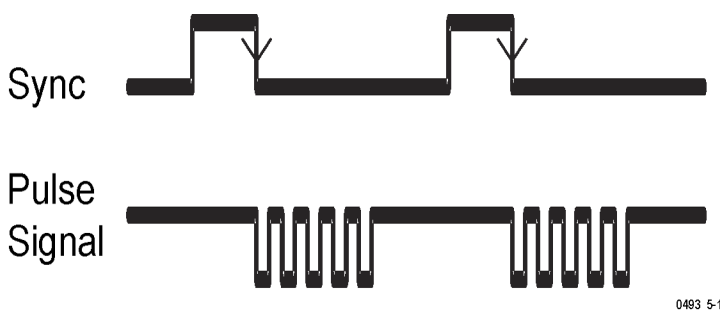

0493_5-1

You can delay the start arming point with respect to the arming signal. Use this function when the external arming signal does not coincide with the part of the signal in which you are interested. The time delay range is 20 ns to 2 s with a setting resolution of 10 ns.

Arm Stop Arm Stop halts a measurement when the instrument detects a level shift with the specified slope on the arming input signal. Combining Arm Start and Arm Stop results in a measurement gate function that sets the total duration of the measurement. For example, use an Arm Start/Stop combination to measure the frequency of a pulsed RF signal, where the position of the start/stop conditions are inside the burst.

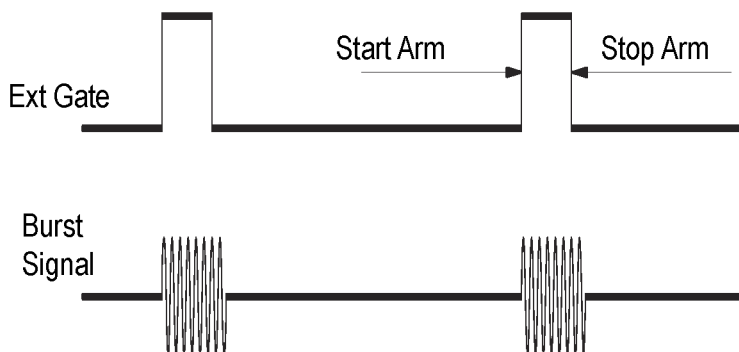

0493_5-2

The available Arm Stop parameters are Channel, Slope, and Delay.

NOTE. *Arm > Stop Delay time can only be used with the Totalize function in the FCA3100 Series instruments.*

Arm Start/Stop and Burst Measurements

Burst measurements taken by using Arm Start/Stop conditions use the normal **Frequency** measurement mode. However, burst measurements that are not taken using arming conditions are done in the self-synchronizing **Frequency Burst** mode, where the instrument does its best to synchronize on the pulse bursts.

In time interval measurements, you can use the stop arming signal as a sort of “external trigger Hold Off signal.” Here you block stop triggering during the external period.

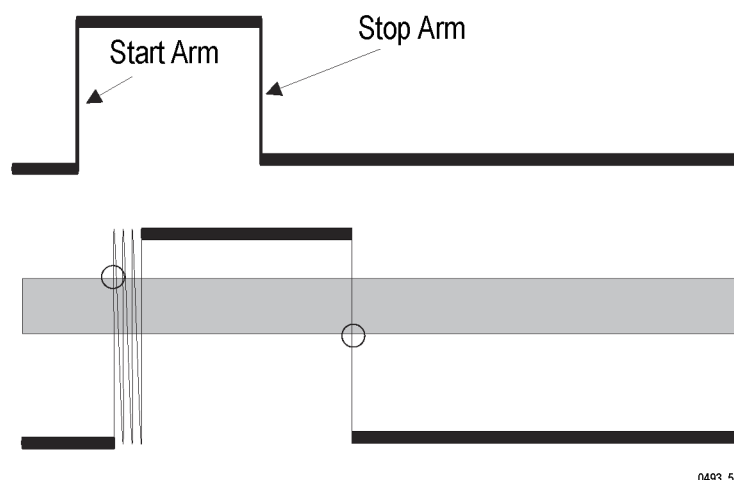

0493_5-3

Arming Input Signals

Input E (on the rear panel) is the normal arming input. It is suitable for arming (sync) signals that have TTL levels. The trigger level is fixed at 1.4 V and cannot be changed. The trigger slope can be set to positive or negative.

You can also use Input A or Input B as arming inputs for all single and dual channel measurements (where the arming signal is one of the measuring signals). These inputs are more suitable if your arming signal does not have TTL levels. All Input A and Input B controls (such as AC/DC, Trigger Level, 50 Ω / 1 M Ω , and so on) can be used to condition the arming signal.

Using the Measuring Signal As an Arming Signal

When performing time or frequency measurements on complex signals having a unique trigger point, you can use Input B arming to make the measuring signal “auto-arm” the instrument. The following example sets the instrument to measure the frequency of a signal after the signal reaches a specified voltage level:

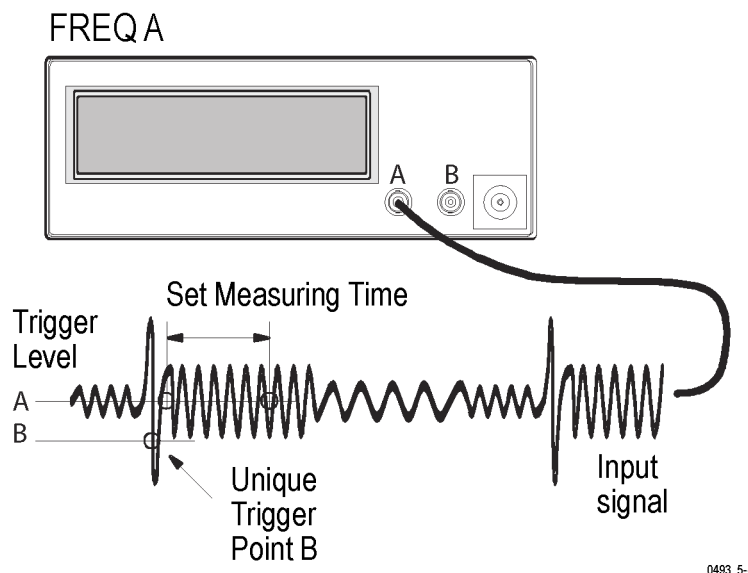

0493_5-4

1. Connect the signal to **Input A**, and to **Input B** with a power splitter.
2. Push **Input A** and adjust the settings to measure the waveform section of interest.
3. Push **Input B** and adjust the settings to detect the unique trigger point. Use **DC** coupling and **Manual** triggering to set a specific level.
4. Push **Settings > Arm**, enable arming, and set the **Start Slope** to detect. Use **Start Delay** if required.
5. Set a measurement time that is appropriate for your signal area of interest.

Arming and Setup Time

The instrument has a 5 nanosecond setup time before the instrument can detect a change on the arming signal.

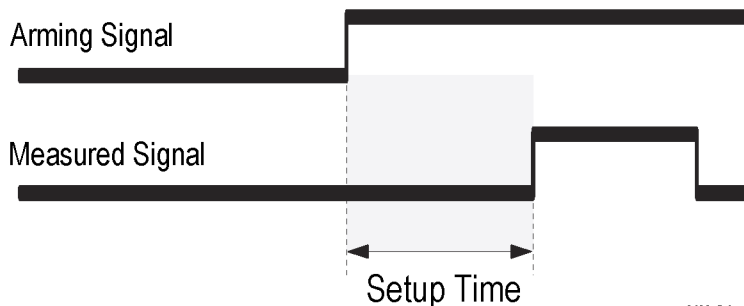

0493_5-6

The setup time is different when using arming delay. The following figure shows the time from the expired time delay until the measurement is armed (-60 to $+40$ ns, for a total of 100 ns delay resolution). The figure shows that a start trigger signal may be detected although it appears 60 nanoseconds before the programmed time delay has expired. The start trigger signal must come 40 nanoseconds after the programmed time delay expires to guarantee correct start of the measurement.

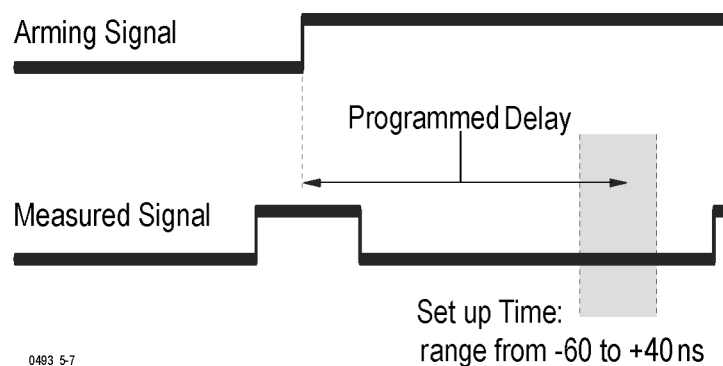

Arming Examples

This section contains examples of how to measure a variety of burst signals. The first two examples measure the pulse width of a selected positive pulse in a burst. The third example measures the time between pulses in a burst. You can also measure the period, rise time, or duty factor of the burst signals by selecting the appropriate measurement, as well as measure on a negative pulse by changing the trigger slope.

If you do not know the basic parameters of the signal to be measured, use an oscilloscope to determine the signal parameters. Use these parameters to set the instrument trigger slope, arming slope, and arming delay.

Arming Example: Measuring the First Pulse in a Burst

This example shows how to measure the width of the first pulse in a repetitive pulse burst. In this example, a synchronization signal (sync) with TTL levels is also available. The quick and simple method described first does not use arming at all but rather draws on the fact that the instrument tends to self-synchronize its internal processes to the input signal.

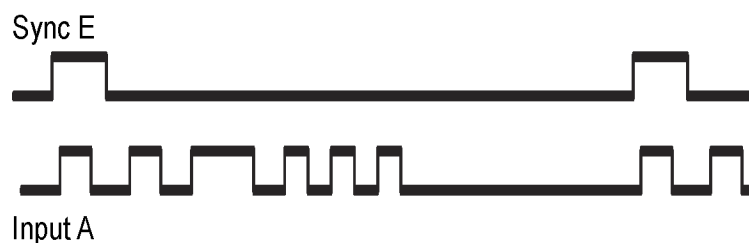

The task is to synchronize the start of the measurement (start trigger) to the leading edge of the first pulse. Depending on the signal timing, this can be easy, difficult, or very difficult.

Auto synchronization without arming. It is possible to measure a pulse within a burst without using the arming function. The instrument can often automatically synchronize the measurement start to the triggering of the first pulse. The conditions for success are:

- The PRF is not too high, preferably below 50 Hz and certainly not above 150 Hz.
- The duration of a pulse burst (between first and last pulse) should be substantially less than the distance to the next burst.
- The number of pulses in the burst should be more than 100 to avoid occasional miscounts.

Do the following to perform auto synchronization without arming:

1. Connect the burst signal to Input A.
2. Set the manual sensitivity and trigger level until the burst signal triggers the instrument correctly.
3. Push **Meas > Pulse > Width Positive > A**.
4. Push **Settings > Stat > Pacing** to set Pacing to **On**.
5. Push **Settings > Stat > Pacing Time** and enter a value that is near the time between the bursts.

Absolute synchronization is not guaranteed using this approach, but there is a good chance that auto-synchronization will work. However, occasional wrong values are displayed. To achieve guaranteed synchronization, use the **Start Arming** function.

Burst pulse synchronization using start arming. You can use an external sync signal to arm the measurement. This requires that the leading edge of the sync signal occurs more than 5 nanoseconds before the leading edge of the first pulse in the burst (See Figure 9.)

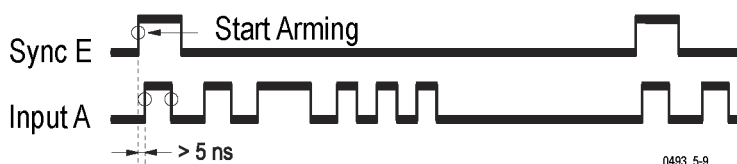

Figure 9: Synchronization using Start Arming.

Do the following to perform synchronization using start arming:

1. Connect the external sync signal to **Input E** (on the rear panel).
2. Connect the burst signal to **Input A**.
3. Adjust the trigger level to trigger on the burst signal.
4. Push **Settings > Arm > Arm On > Sample**.
5. Push **Start Chan > E**.
6. Push **Start Delay** and verify or set the value to zero.
7. Repeatedly push **Save | Exit** to return to the main screen.
8. Push **Meas > Pulse > Width Positive > A**.

If there is no (or too little) time difference between the arming signal and the first pulse in the pulse burst, arming must be combined with a delay, as shown in the next example.

Burst Pulse Synchronization Using Start Arming With Time Delay. If the pulse bursts have a stable repetition frequency, you can use Start Arming with Time Delay to take the measurement. This method uses the sync pulse belonging to a preceding burst to synchronize the start of a measurement. Set the time delay to a time longer than the duration of a pulse burst and shorter than the repetition time of the pulse bursts, as shown in the following figure.

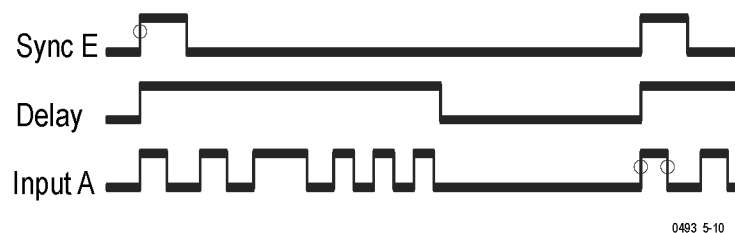

0493_5-10

Figure 10: Synchronization using start arming with time delay.

Do the following to perform synchronization using start arming with time delay:

1. Connect the external sync signal to **Input E** (on rear panel).
2. Connect the burst signal to **Input A**.
3. Adjust the trigger level to trigger on the burst signal.
4. Push **Settings > Arm > Arm On > Sample**.
5. Push **Start Chan > E**.
6. Push **Start Delay** and enter a suitable delay value (longer than the duration of a pulse burst but shorter than the repetition time of the pulse bursts).

7. Repeatedly push **Save** | **Exit** to return to the main screen.
8. Push **Meas > Pulse > Width Positive > A**.

**Arming Example:
Measuring the Second
Pulse in a Burst**

This example shows how to measure the width of the second pulse in the pulse train. The problem is how to synchronize the measurement start to the start of the second pulse. In this case, auto synchronization (without the use of the arming function) cannot work; auto synchronization only synchronizes on the first trigger event in a burst. This means that this measurement needs to use the Arming function.

Depending on the sync signal's position relative to the burst, and the duration of the sync signal, the measurement can be performed with or without using arming delay. If the trailing edge of the sync signal occurs after the leading edge of the first pulse but before the second pulse in the pulse burst, then normal start arming without delay can be used.

Select triggering on positive slope on Input A and negative slope on Input E. The slope for the active arming channel is set in the **Settings > Arm > Start Slope** menu. The following figure shows when the trailing edge of the sync signal appears before the second pulse.

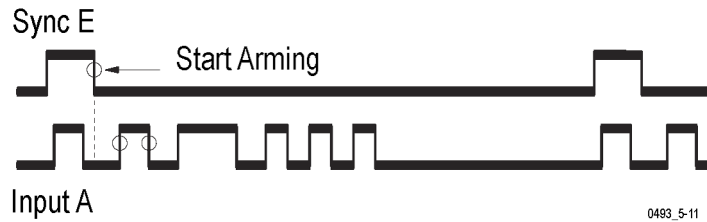

If the sync-pulse timing is not as suitable as in the above measurement example, such as when the trailing edge of the sync signal is too late, then combine arming with a time delay; as shown in the following figure.

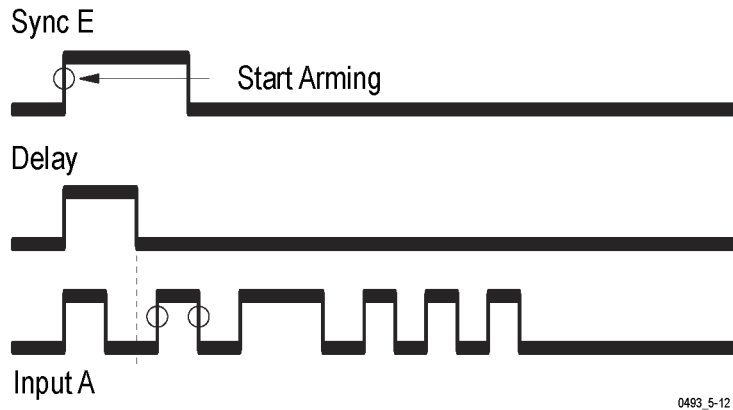

Use the same procedure as in the preceding example but set a suitable **Start Arm Delay** so that delay expires in the gap between the first and second pulse.

Arming Example: Measuring the Time Between Pulses in a Burst

In the previous examples, the synchronization task identified the start of a measurement and performed a single-shot time interval measurement. The following example measures the time between the rising edge of the first and fourth pulses in a burst, as shown in the following figure. This requires setting both a start and stop time to take the measurement.

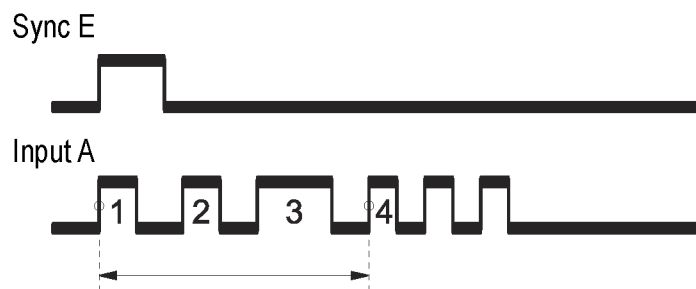

0493_5-13

This type of measurement uses the **Time Interval A to A** function, and the signal on Input B to control the stop conditions. The task is to arm both the start and the stop of this measurement. The start arming is already described in the first arming example (synchronizing the measurement start to the leading edge of the first pulse). The challenge is to synchronize the stop of the measurement (arm the stop). This can be done using either of the following methods:

Using trigger hold off to delay the stop a certain time. Trigger Hold Off is used to inhibit stop triggering during a preset time. The Hold Off period starts synchronously with the start trigger event. The Hold Off time should be set to expire somewhere between pulse number 3 and 4.

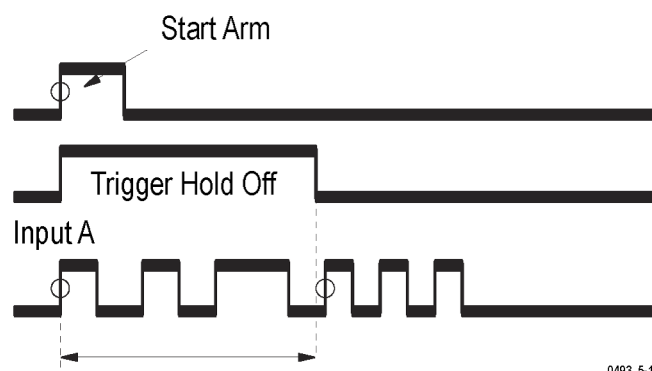

0493_5-14

Use the same test setup as in the preceding examples. Then proceed as follows:

- Push the **Meas** button and select **Time Interval A to A**.
- Push **Input B** and choose positive slope and a suitable trigger level.
- Push **Settings > Trigger Hold Off (On)** and enter a suitable Hold Off time.

- Make sure the start arming conditions from example #1 are maintained, that is no arming delay.
- Measure the signal.

Using stop arming (External hold off) to delay the stop. So far in these examples, the sync signal was used exclusively as a start arming signal; that is, the measurement triggering has focused on the leading edge of the sync signal, and not its duration. However, the sync signal can also be used as an External Trigger Hold Off by using Stop Arming on the trailing edge of the sync signal. If the duration of the sync pulses can be externally varied, select a duration that expires in the gap between the third and fourth pulses, as shown in the following figure.

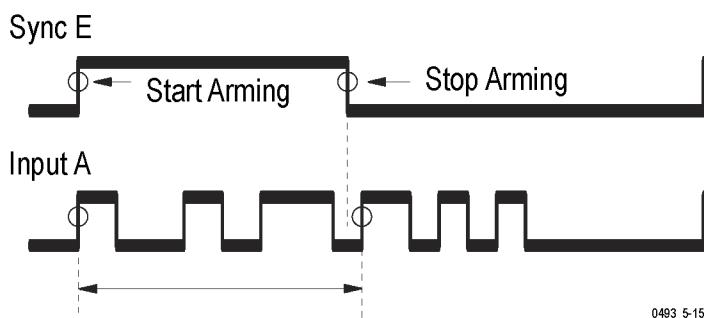

Use the same test setup as in the preceding example. Then proceed as follows:

1. Push **Settings > Arm > Stop Chan > E**.
2. Push **Stop Slope > Falling**.
3. Measure the signal.

Arming and Profiling

Profiling means measuring frequency over time. Examples include measuring the warm-up drift in a signal source over hours, measuring the linearity of a frequency sweep during seconds, VCO switching characteristics during milliseconds, or the frequency changes inside a chirp radar pulse over microsecond periods.

These instruments can handle many profiling measurement situations, with some limitations. Profiling can theoretically be done manually, that is, by reading individual measurement results and plotting in a graph. However, the optimum way is to use the instrument as a fast, high-resolution sampling front-end, storing results in its internal memory, and then transferring the measurements to a software application for analysis and graphical presentation. The TimeView™ software application greatly simplifies profiling.

There are two profiling measurements: *free-running* and *repetitive sampling*.

Free-Running Measurements

Free-running measurements are performed over a longer period. Typical free-running measurements include determining the stability of an oscillator over a 24-hour period, measuring the initial drift of a generator during a 30-minute warm-up time, or measuring the short-term stability of a device. In these cases, measurements are taken at user-selected intervals in the range of 2 μ s to 1000 s.

There are several ways to set a measurement interval:

- Use pacing time (Settings > Stat) to set the measurement interval. Measurements continue until the set number of samples is taken. Use **Hold/Run** and **Restart** to stop a measurement after one full cycle. View the trend or spread on a statistical display (Trend Plot or Histogram) while the measurement is proceeding.
- Use the timer in a remote controller. This allows for synchronization with external events, for instance a change of DUT when checking a series of components.
- Use external arming signals. For example, use a 10 Hz arming signal pulse to take measurements at 100 ms intervals.
- Take measurements in free-run mode. When the instrument is free-running (continuous measurements), the shortest delay between measurements is approximately 4 μ s (internal calibration Off) or 8 μ s (internal calibration On) plus the set measurement time. For example, with a measurement time of 0.1 ms, the time between each sample is approximately 104 – 108 μ s.

Repetitive Sampling Profiling Measurements

Free-running measurements will not work when the profiling demands less than 4 μ s intervals between samples. For example, how would you profile a VCO step response with 100 samples during a 10 ms time period?

This measurement scenario requires a *repetitive* input step signal. You have to repeat your measurement 100 times, take one new sample per cycle, and delay each new sample by 100 μ s with respect to the previous sample.

The easiest way to do this is by means of a controller, for example a PC loaded with TimeView software, although it is possible (but tedious) to manually set and perform all 100 measurements.

The following are required to set up a repetitive sampling profiling measurement:

- A repetitive input signal (such as the frequency output of a VCO).
- An external sync signal (such as the step voltage input to a VCO).
- Use of arming delayed by a preset time (100 μ s, 200 μ s, 300 μ s).

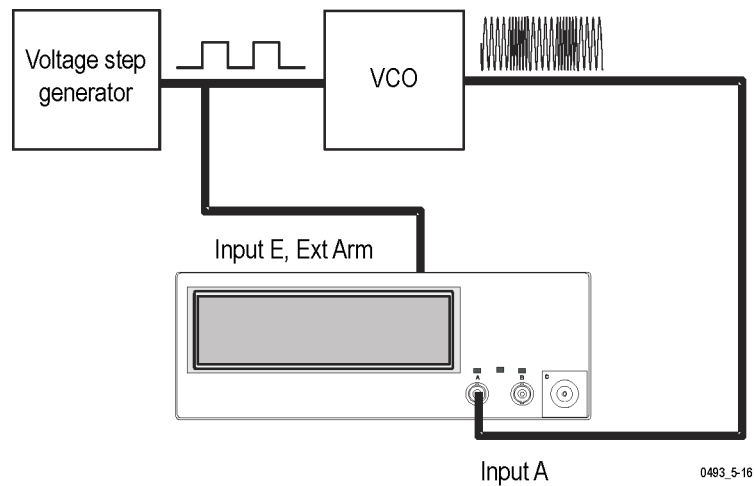
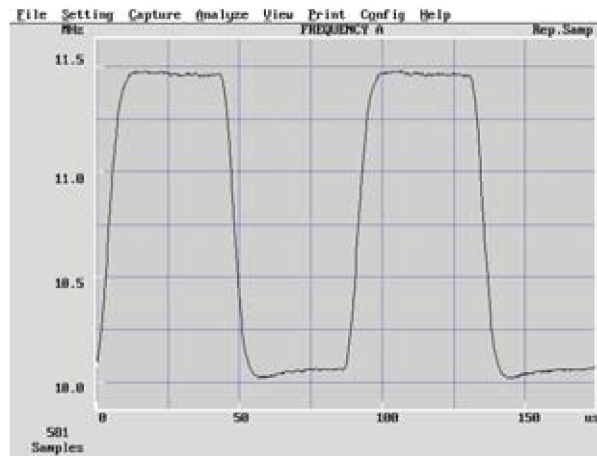

Figure 11: Setup for transient profiling of a VCO.



0493_5-17

Figure 12: Results from a transient profiling measurement.

Use the results of all 100 measurements to plot frequency versus time. Note that the absolute accuracy of the time scale is dependent on the input signal itself. Although the measurements are armed at $100 \mu\text{s} \pm 100 \text{ ns}$ intervals, the actual start of measurement is always synchronized to the first input signal trigger event after arming.

Appendix A: Default Instrument Settings

The following table lists the factory default instrument settings. Push **User Opt > Save/Recall > Setup > Recall setup > Default** to set the instrument to these settings. (See page 18.)

Parameter	Default value
Input A & B	
Trigger Level	Auto
Trigger Slope	Rising (Positive)
Impedance	1 M Ω
Attenuator	1x
Coupling	AC
Filter	Off
Arming	
Start	Off
Start Slope	Rising (Positive)
Start Arm Delay	0
Stop	Off
Stop Slope	Rising (Positive)
Hold-Off	
Hold-Off State	Off
Hold-Off Time	200 μ s
Time-Out	
Time-Out State	Off
Time-Out Time	100 ms
Statistics	
Statistics	Off
Number of Samples	100
Number of Bins	20
Pacing State	Off
Pacing Time	20 ms
Mathematics	
Mathematics	Off
Math Constants	K=1, L=0, M=1
Limits	
Limit State	Off
Limit Mode	Range
Lower Limit	0
Upper Limit	0

Burst	
Sync Delay	400 μ s
Start Delay	0
Measure Time	200 μ s
Freq. Limit	300 MHz
Miscellaneous	
Function	Freq A
Smart Frequency	Auto
Smart Time Interval	Off
Measure Time	200 ms
Auto Trig Low Freq	100 Hz
Time base Reference	Auto
Blank Digits	0

Appendix B: Controlling Measurement Timing

The Measurement Process

Since these instruments use the reciprocal counting technique, they always synchronize the start and stop of the actual measuring period to the input signal trigger events. A new measurement automatically starts when the previous measurement is finished (unless **Hold** is on). This is ideal for continuous wave signals.

The start of a measurement takes place when the following conditions have been met (in order):

- The instrument has fully processed the previous measurement.
- All preparations for a new measurement are made.
- The input signal triggers the instrument's measuring input.

The measurement ends when the input signal meets the stop trigger conditions. That happens directly after the following events:

- The set measurement time has expired (applies to **Frequency** and **Period Average** measurements only).
- The input signal fulfils the stop trigger conditions, normally when it passes the trigger window the second time.

Resolution As a Function of Measurement Time

The quantization error and the number of digits on the display mainly define the resolution of the instrument (the least-significant digit displayed). As explained under *Reciprocal Counting* (See page 31.), the calculated frequency f is:

$$f = \frac{n}{t_g}$$

while the relative rms quantization error $E_q = \pm 100 \text{ ps}/t_g$.

The instrument truncates irrelevant digits so that the rms quantization resolution cannot change the LSD (least-significant digit) more than ± 5 units. This occurs when the displayed value is 99999999, and the quantization error is worst case. The best case is when the displayed value is 10000000. Then the quantization resolution corresponds to ± 0.5 LSD units.

NOTE. ± 1 unit in 99999999 ($=1E8$) means 10 times more relative resolution than ± 1 unit in 10000000 ($=1E7$), despite the same number of digits.

A gradual increase of the measurement time reduces the instability in the LSD caused by the quantization uncertainty. At a specific measurement time setting, the instrument is justified to display one more digit. That one additional digit suddenly gives ten times more display resolution, but not a ten times less quantization uncertainty. So a measurement time that gives just one more display digit shows more visual uncertainty in the last digit.

For a stable LSD readout, the maximum measurement time selected should be one that still gives the required number of digits. Such optimization of the measurement time enables the total resolution to be equal to the quantization resolution.

Measurement Time and Rates

The set measurement time decides the length of a measurement if Frequency or Period Average is selected. This is important to know when you want to make fast measurements, such as when you are using the statistics features, or when you are collecting data over the GPIB bus.

The time between the stop of one measurement and the start of the next one in the course of a block measurement (often referred to as dead time), can be below 2 μ s.

A block is a collection of consecutive measurements, the results of which are stored in local memory for statistics or plotting purposes (**Analyze** mode) or for later transfer to a controller over a GPIB or USB data communication link.

Additional Measurement Controls

Additional controls over start and stop of measurements. Instrument measurements can get more complex. Besides input signal triggering, you can control the *start* of a measurement using the following functions:

- Manual **Restart**, if the instrument is in **Hold** mode.
- GPIB triggering (<GET> or *TRG), if bus triggering is selected. GPIB triggering is described in the programmer manual.
- External arming signal, if **Start Arming** is active.
- Expired start arming delay, if **Arming Delay** is active.

In addition to expired measurement time and stop signal triggering, the *stop* of a measurement is further controlled by external arming signal triggering, if **Stop Arming** is active.

Index

A

- About (the instrument), 19
- Above (limit testing), 71
- AC input coupling, 22
- Additional measurement controls, 88
- Adev, 67
- Alarm (limit testing), 71
- Alarm_stop (limit testing), 71
- Allan Deviation, 67
- AM modulating frequency measurement, 45
- AM signals, 44
- Analog low-pass filter, input, 23
- Analyze button, 10
- Analyze modes, 7
- Arm, 15
- Arming
 - Arm Start, 74
 - Arm Stop, 74
 - arming signal from measuring signal, 75
 - burst measurements, 75
 - examples, 77, 80, 81
 - input signals, 75
 - measuring signal as arming signal, 75
 - non-cyclic signals, 73
 - overview, 73
 - profiling, 73, 82
 - pulse signals, 73
 - setup time, 76
 - single-shot events, 73
 - synchronizing signals, 75
 - Time delay (Arm Start), 74
 - trigger signals, 75
 - using input signal to arm, 75
- Arrow buttons, 12
- Attenuation, input, 21
- Auto Set button, 11
- Auto Trig Low Freq, 16, 24
- Auto trigger, 24, 28
- Average and single cycle measurements, 32

- Average period measurement, 46, 47

B

- Back-to-back frequency measurement, 47
- Back-to-back period measurement, 46
- Battery supply (MCA3000), 2, 6
- Below (limit testing), 71
- Burst, 15
 - measurement, 38
 - measurement errors, 41
 - measurements and Arming, 75
 - selecting burst measure time, 40
 - triggering, 39
- Bus Type (Interface), 18
- Buttons
 - Analyze, 10
 - arrow, 12
 - Auto Set, 11
 - down arrow, 12
 - Enter, 12
 - Esc, 11
 - Esc button and remote operation, 7
 - Hold/Run, 13
 - Input A, Input B, 12, 14
 - keypad, 12
 - left arrow, 12
 - Math/Limit, 13, 17
 - Meas, 10
 - Navigation, 12
 - Restart, 14
 - right arrow, 12
 - Save/Exit, 11
 - Settings, 13, 15
 - up arrow, 12
 - User Opt, 13, 18
 - Value, 10

C

- Calculating measurement confidence limits, 69
- Calibrate, 18
- Calibration date, 19
- Capture (limit testing), 71
- Carrier wave frequency, 42
- Carrier wave frequency measurement, 44
- Compensating for phase errors, 57
- Confidence limits, measurement, 69
- Convert auto trigger level to manual, 25
- Coupling, input, 22
- CW measurement, 44

D

- Dataset (Save/Recall), 18
- Dataset submenu
 - Erase, 18
 - Recall, 18
 - Save, 18
- DC input coupling, 22
- Default instrument settings, 85
- Digit Blanks, 19
- Digital low-pass filter, input, 23
- Down arrow button, 12
- Down converter (microwave measurement), 35
- Drift and jitter, 68
- Duty Factor measurement, 51

E

- Enter button, 12
- Erase (dataset item), 18
- Esc button, 11
- Esc button and remote operation, 7

Examples

- calculating confidence limits, 69
- math expressions, 66, 67
- measure deviation from specified frequency, 66
- measure first pulse width in a burst (arming), 77
- measure second pulse width in a burst (arming), 80
- measure time between pulses in a burst (arming), 81
- Totalize A, Start/Stop by B, 60
- Totalize A-B Gated by E, 61
- totalize and arming, 60
- Totalize B Timed by A, 61
- using math expressions, 66

F

- Factory instrument settings, 85
- Fast GPIB bus, viii
- Faster measurements, 24
- Features, v
- Free-running measurements, 83
- Frequency (fo), 42
- Frequency measurement, 36
- Frequency measurement (Input C), 38
- Frequency modulated signals, 41
- Frequency ratio, 38

G

GPIB

- address, 18
- bus speed, viii
- mode (native or compatible), 18

H

- Harmonic distortion, 29
- Histogram display, 8
- Hold/Run button, 13
- How sync delay works, 40

I

- Impedance, input, 21
- Inaccuracies (phase), 55
- Input
 - A and B (Arming), 75
 - analog low-pass filter, 22
 - arming trigger signals, 75
 - attenuation, 21
 - coupling, 22
 - digital low-pass filter, 22
 - impedance, 21
 - Input E (Arming), 75
 - low-pass filter, 22
 - using input signal to arm, 75
- Input A button, 14
- Input A, B buttons, 12
- Input A, B menus, 14
- Input B button, 14
- Input C Acq, 16
- Input controls, 21
- Installed option information, 19
- Instrument information, 19
- Instrument settings, default, 85
- Interface, 18
- Interface submenu
 - Bus Type, 18
 - GPIB Address, 18
 - GPIB Mode, 18
- Interference, 26
- Interpolator Calibration, 16

J

- Jitter and drift, 68

K

- K (math formula constant), 17
- Keypad buttons, 12

L

- L (math formula constant), 17
- Left arrow button, 12
- Limit Behavior, 17
- Limit Mode, 17

Limit submenu

- Limit Behavior, 17
- Limit Mode, 17
- Lower Limit, 17
- Upper Limit, 17

Limit testing, 71

- Above setting, 71
- Alarm setting, 71
- Alarm_stop setting, 71
- Below setting, 71
- capture setting, 71
- Limit Behavior setting, 71
- LL (lower limit), 72
- Range setting, 71
- UL (upper limit), 72

Limits, 71

- Limits and analyze mode, 72
- LL (limit testing), 72
- Low frequency signal, 33
- Low modulation frequencies, 43
- Low-pass filter, input, 22
- Lower Limit, 17
- LP filter, analog, 23
- LP filter, digital, 23

M

- M (math formula constant), 17
- Manual trigger, 24, 29
- Manual trigger levels, 25
- Math, 17
- Math expressions, 65, 66
- Math submenu
 - K, 17
 - L, 17
 - M, 17
 - Math, 17
 - X, 17
- Math/Limit button, 13, 17
- Math/Limit menu, 17
- Max, 66
- Maximum frequency, 43
- MEAN, 66
- Meas button, 10
- Meas Time, 15
- Measurement time, 65
- Measurements
 - additional controls, 88

- Adev (Allan deviation), 66
- alarms (limit testing), 71
- AM carrier wave, 44
- AM signals, 44
- amplitude modulating
 - frequency, 45
- Arm (burst
 - measurements), 75
- Arm Start, 74
- Arm Stop, 74
- arming and input signals, 75
- arming and measuring
 - signals, 75
- arming and profiling, 82
- arming examples, 77
- arming input signals, 75
- arming overview, 73
- arming setup time, 76
- average period, 46, 47
- back-to-back frequency, 47
- back-to-back period, 46
- burst measurements and
 - Arming, 75
- burst signals, 38
- Carrier wave frequency, 42
- compensating for phase
 - errors, 57
- confidence limits,
 - calculating, 69
- drift and jitter, 68
- Duty Factor, 51
- FM, 41
- free-running, 83
- frequency (Input A, B), 36
- frequency (Input C), 38
- frequency ratio, 38
- frequency, back-to-back, 47
- how sync delay works, 40
- input signals and arming, 75
- jitter and drift, 68
- Limit Behavior setting, 71
- limit test modes, 71
- limit testing, 71
- limit testing and analyze
 - mode, 72
- low mod. frequencies, 43
- math, 66
- math expressions, 65
- Max, 66
- maximum frequency, 43
- Mean, 66
- measure deviation from
 - specified frequency, 66, 67
- measure first pulse width in a
 - burst, 77
- measure second pulse width
 - in a burst, 80
- measure time between pulses
 - in a burst, 81
- measurement process, 87
- measurement speed and
 - statistics, 68
- measurement time, 68
- measurement time span, 65
- Min, 66
- minimum frequency, 43
- mod. frequencies above 1
 - kHz, 43
- overdrive and pulse
 - rounding, 52
- P-P, 66
- p-p frequency deviation, 44
- Period, 46
- period, average, 47
- period, back-to-back, 46
- phase, 54
- phase error compensation, 57
- phase errors by frequency;
 - table, 56
- phase innacuracy, 55
- phase measurement errors, 55
- phase measurement
 - resolution, 55
- possible phase errors, 55
- pulse rounding and
 - overdrive, 52
- pulse width, 51
- random errors, phase
 - measurements, 55
- repetitive sampling
 - profiling, 83
- Rise/Fall time, 49
- setting sampling
 - parameters, 67
- setup time, arming, 76
- single period, 46
- speed up statistical
 - measurements, 68
- statistical measurements, 66
- Std (standard deviation), 66
- systemic errors, phase
 - measurements, 56
- theory of measurement, 31
- TIE, 50
- time and rates, 87, 88
- time interval, 49
- time interval error (TIE), 50
- time measurement errors, 52
- time measurement trigger, 48
- totalize, 59
- totalize and arming, 60
- Uncertainty calculation, 69
- using math expressions, 65
- Vmax, 63
- Vmin, 63
- voltage, 63
- Vpp, 63
- Vrms, 63
- Measuring speed, 32
- Menu
 - Input A, Input B, 14
 - Math/Limit, 17
 - Settings, 15
 - User Opt, 18
- Menu mode, 7
- Microwave measurement
 - theory, 35
- Min, 66
- Minimum frequency, 43
- Misc, 16
- Misc menu
 - Auto Trig Low Freq, 16
 - Input C Acq, 16
 - Interpolator Calibration, 16
 - TIE, 16
 - Timeout, 16
- Modify Labels, 18
- Modulation frequencies above 1
 - kHz, 43

N

Navigation buttons, 12
 Noise, 26
 Non-cyclic signals, 73
 Numerical statistical measurements, 7

O

Optional battery supply (MCA3000), 2, 6
 Overdrive and pulse rounding, 52

P

P-P, 66
 P-P frequency deviation, 44
 Period measurement, 46
 Phase, 54
 Phase error compensation, 57
 Phase errors by frequency; table, 56
 Possible errors (phase), 55
 Prescalers and minimum measurement time, 32
 Profiling, 73, 82
 Pulse rounding and overdrive, 52
 Pulse signals, 73
 Pulse Width time measurement, 51

R

Random errors, phase measurements, 55
 Range (limit testing), 71
 Recall (dataset), 18
 Recall (instrument setup), 18
 Reciprocal counting, 31
 Reduce interference, 26
 Reduce noise, 26
 Remote operation
 Esc button, 7
 status, 7
 Repetitive sampling profiling measurements, 83
 Resolution, 87

Resolution (phase), 55
 Restart button, 14
 RF signal measurement theory, 34
 Right arrow button, 12
 Rise/Fall time measurement, 49

S

Safety Summary, iii
 Sample-Hold, 31
 Save, 18
 Save Current Setup, 18
 Save/Exit button, 11
 Save/Recall, 18
 Save/Recall submenu
 Dataset, 18
 Setup, 18
 Total Reset, 18
 Selecting burst measure time, 40
 Set manual trigger value, 25
 Setting Sampling Parameters, 67
 Settings button, 13, 15
 Settings menu, 15
 Arm, 15
 Burst, 15
 Meas Time, 15
 Misc, 16
 Stat, 15
 Timebase, 15
 Trigger Hold Off, 15
 Setup, 18
 Setup Protect, 18
 Setup submenu
 Modify Labels, 18
 Recall Setup, 18
 Save Current Setup, 18
 Setup Protect, 18
 Setup time, arming, 76
 Single measurement, 13
 Single period measurement, 46
 Single-shot events, 73
 Smart Measure, 16
 Speed up statistical measurements, 68
 Standard Deviation, 66, 67
 Start Test, 18

Stat, 15
 Statistical measurements, 7
 Statistics, 66
 Statistics and mathematics, 69
 Statistics and Measurement
 Speed, 68
 Std, 66
 Stop measurements (Hold), 13
 Sync delay, 40
 Systemic errors, phase measurements, 56

T

Taking a single measurement, 13
 Test, 18
 Test Mode, 18
 Test submenu
 Start Test, 18
 Test Mode, 18
 Theory of measurement, 31
 avg and single cycle measurements, 32
 down converter, 35
 low frequency signals, 33
 measuring speed, 32
 microwave, 35
 prescalers, 34
 prescalers and min measurement time, 32
 RF signal, 34
 Sample-Hold, 31
 Time-Out, 32
 TIE, 16, 50
 Time delay (Arm Start), 74
 Time interval, 49
 Time interval error (TIE), 50
 Time measurement errors, 52
 Time measurement trigger, 48
 Time-Out, 32
 Timebase, 15
 Timeout, 16
 Total Reset, 18
 Totalize, 59
 Totalize and arming, 60
 Trend plot display, 9

Trigger

- Auto (Wide) Hysteresis, 28
- convert auto trigger level to manual, 25
- faster measurements, 24
- harmonic distortion, 29
- Hold Off, 15
- Hysteresis, 27
- level setting, 28
- manual trigger, 29
- narrow hysteresis, 29
- set manual trigger value, 25
- set trigger mode, 24
- time measurement, 48

U

- UL (limit testing), 72
- Uncertainty calculation, 69
- Up arrow button, 12
- Upper Limit, 17
- User Opt button, 13, 18
- User Opt menu, 18
 - About, 19
 - Calibrate, 18
 - Digit Blanks, 19
 - Interface, 18
 - Save/Recall, 18
 - Test, 18

V

- Value button, 10
- Vmax, 63
- Vmin, 63
- Voltage measurements, 63
- Vpp, 63
- Vrms, 63

X

- X (math formula), 17